

Natural Gas & Climate Change

Eric D. Larson, PhD



Natural Gas & Climate Change

Eric D. Larson, PhD

Princeton

One Palmer Square, Suite 330
Princeton, NJ 08542

Phone: +1 609 924-3800

Call Toll Free

+1 877 4-CLI-SCI (877 425-4724)

www.climatecentral.org

Climate Central surveys and conducts scientific research on climate change and informs the public of key findings. Our scientists publish and our journalists report on climate science, energy, sea level rise, wildfires, drought, and related topics. Climate Central is not an advocacy organization. We do not lobby, and we do not support any specific legislation, policy or bill. Climate Central is a qualified 501(c)3 tax-exempt organization.

Climate Central scientists publish peer-reviewed research on climate science; energy; impacts such as sea level rise; climate attribution and more. Our work is not confined to scientific journals. We investigate and synthesize weather and climate data and science to equip local communities and media with the tools they need.

May 2013

Report Author

Eric D. Larson, PhD

Senior Scientist

Dr. Larson leads energy-related research at Climate Central while also being part of the research faculty at Princeton University in the Energy Systems Analysis Group of the Princeton Environmental Institute. His research interests include engineering, economic, and policy-related assessments of advanced clean-energy technologies and systems. He has published over 80 peer-reviewed articles and more than 200 papers in total. He has a Ph.D. in Mechanical Engineering from the University of Minnesota.

Contents

Key Findings	1
Report in Brief	4
1. Introduction	10
2. EPA Estimates of GHG Emissions from the Natural Gas Supply System	21
2.1 Gas Production	24
2.2 Gas Processing	25
2.3 Gas Transmission and Storage	25
2.4 Gas Distribution	26
3. Other Estimates of GHG Emissions from the Natural Gas Supply System. ..	28
3.1 Leakage During Gas Production, Processing, and Transmission.. ..	29
3.2 Leakage from Gas Distribution Systems	32
4. Natural Gas vs. Coal in Electricity Generation	32
5. References.	41

Key Findings

Knowing how much methane is leaking from the natural gas system is essential to determining the potential climate benefits of natural gas use. Climate Central's extensive review of the publicly available studies finds that a pervasive lack of measurements makes it nearly impossible to know with confidence what the average methane leak rate is for the U.S. as a whole. More measurements, more reliable data, and better understanding of industry practices are needed.

It has been widely reported that shifting from coal to gas in electricity generation will provide a 50 percent reduction in greenhouse gas emissions. In reality, the extent of reduced global warming impact depends largely on three factors:

1. The methane leak rate from the natural gas system;
2. How much time has passed after switching from coal to gas, because the potency of methane as a greenhouse gas is 102 times that of carbon dioxide (on a pound-for-pound basis) when first released into the atmosphere and decays to 72 times CO₂ over 20 years and to 25 times CO₂ over 100 years, and;
3. The rate at which coal electricity is replaced by gas electricity.

Climate Central has developed [an interactive graphic incorporating all three factors](#). This makes it easy to visualize the greenhouse benefits of converting power generation from coal to natural gas for different assumptions of methane leak rates and coal-to-gas conversion rates while also considering methane's greenhouse potency over time.

The EPA recently estimated methane leaks in the natural gas system at 1.5 percent. A 1.5 percent leak rate would achieve an immediate 50 percent reduction in greenhouse gas (GHG) emissions, at the individual power plant level. However, EPA's estimate contains significant uncertainty, and like all estimates available in the peer-reviewed literature, lacks sufficient real-world measurements to guide decision-making at the national level. Climate Central found that the ongoing shift from coal to gas in power generation in the U.S. is unlikely to provide the 50 percent reduction in GHG emissions typically attributed to it over the next three to four decades, unless gas leakage is maintained at the lowest estimated rates (1 to 1.5 percent) and the coal replacement rate is maintained at recent high levels (greater than 5 percent per year).

The climate benefits of natural gas are sensitive to small increases in leak rates. Assuming that natural gas replaces 2.5 percent of coal-fired power each year (the average over the past decade) even a relatively low overall leak rate of 2 percent would not achieve a 50 percent reduction in GHG emissions compared to the current fleet of coal-fired power plants, for over 100 years. If the leak rate were as high as 8 percent, there would be no climate benefit at all from switching to natural gas for more than 60 years.

To compute these estimates, we analyzed first the potential GHG benefits from replacing the electricity generated by a single coal power plant with electricity from natural gas instead. For an individual power plant, if the leak rate were 2 percent it would take 55 years to reach a 50 percent reduction in greenhouse impacts compared to continued coal use. If the leak rate is more than 6 percent of methane production, switching to natural gas provides zero global warming benefit for the first 5 years compared to continuing with coal. The switch achieves a modest 17 percent reduction in GHG emissions after 37 years (or by 2050, if the switch occurs in 2013). An 8 percent leak rate increases GHG emissions until 2050 compared with continued coal use, and produces only about 20 percent less climate pollution than continued coal use after 100 years of operation.

But unlike converting a single power plant from coal to natural gas, the U.S. cannot switch its entire fleet of coal-fired power plants to natural gas all at once. When substitution is analyzed across the entire fleet of coal-fired plants, the rate of adoption of natural gas is a critical factor in achieving greenhouse benefits. The rate of adoption is analyzed together with the powerful but declining potency of methane emissions over time. Each year, as a certain percentage

It will be Decades Before Switching to Natural Gas From Coal Power Brings a 50 Percent Reduction in Emissions

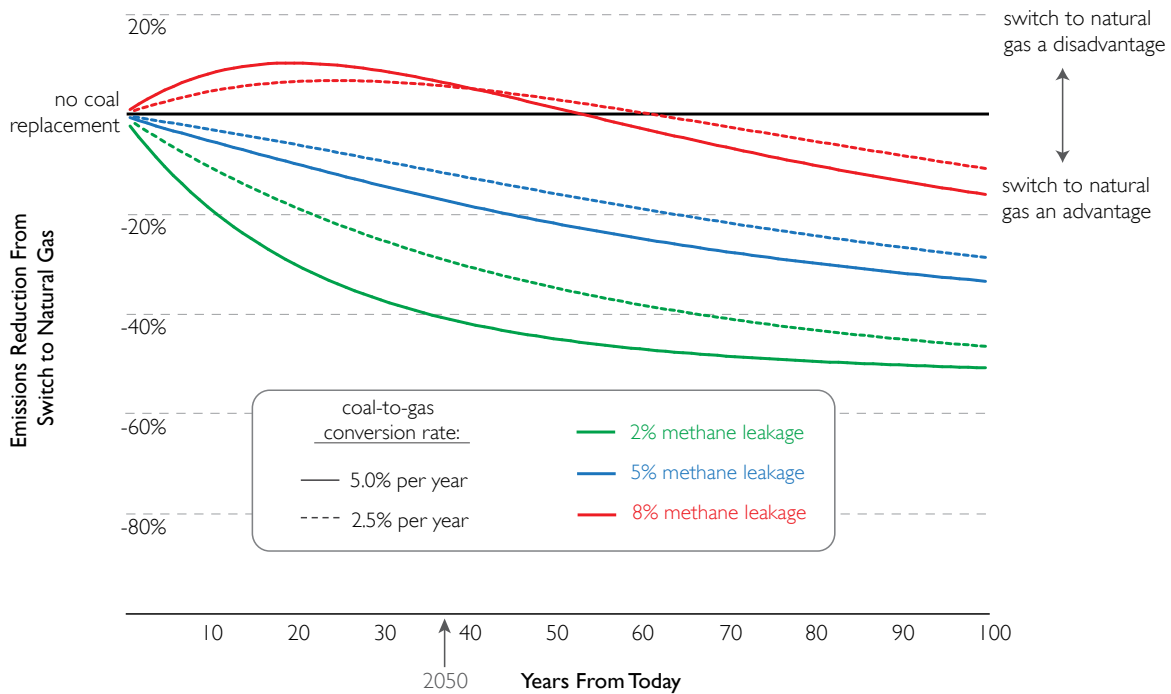

of coal plants are converted to natural gas, a new wave of highly potent methane leaks into the atmosphere and then decreases in potency over time.

When the rate of adoption is included, the GHG benefits of switching to natural gas can be even more elusive. With a 2 percent methane leak rate, and an average annual conversion rate of electricity from coal to gas of 2.5 percent (a rate that would be supportable with new gas production projected by the U.S. Department of Energy) the reductions would be 29 percent by 2050 and 16 percent by 2030. If methane leakage is 5 percent of production, by 2050 the U.S. would reduce the global warming impact of its fleet of coal fired power plants by 12 percent. By 2030, the reductions would be just 5 percent. With an 8 percent leak rate, GHG emissions would be greater than with coal for more than 50 years before a benefit begins to be realized.

What is the natural gas leak rate in the U.S.? There are large differences among published estimates of leakage from the natural gas supply system, from less than 1 percent of methane production to as much as 8 percent. At the basin level, studies have reported methane leak rates as high as 17 percent. The EPA's 2012 annual greenhouse gas emissions inventory estimate was 2.2 percent. Its 2013 inventory estimate made a large adjustment that reduced the estimate to 1.5 percent. The degree of methane leakage is uncertain, but it is likely to be reduced in the future since it also represents lost profits for gas companies. Nevertheless, our analysis indicates that the ongoing shift from coal to gas in power generation in the U.S. over the next three to four decades is unlikely to provide the 50 percent benefit that is typically attributed to such a shift.

Determining methane leakage is complicated by various uncertainties:

- Large variability and uncertainty in industry practices at wellheads, including:
 - Whether methane that accompanies flowback of hydraulic fracking fluid during completion of shale gas wells is captured for sale, flared, or vented at the wellhead. Industry practices appear to vary widely.

- Liquids unloading, which must be done multiple times per year at most conventional gas wells and at some shale gas wells. Gas entrained with the liquids may be vented to the atmosphere. There have been relatively few measurements of vented gas volumes, and estimating an average amount of methane emitted per unloading is difficult due to intrinsic variations from well to well.
- Lack of sufficient production experience with shale gas wells:
 - There are orders of magnitude in variability of estimates of how much gas will ultimately be recovered from any given shale well. This makes it difficult to define an average lifetime production volume per well, which introduces uncertainty in estimating the percentage of gas leaked over the life of an average well.
 - The frequency with which a shale gas well must be re-fractured to maintain gas flow. This process, known as a well workover, can result in methane emissions. The quantity of emissions per workover is an additional uncertainty, as it depends on how workover gas flow is handled.
- The leak integrity of the large and diverse gas distribution infrastructure:
 - Leakage measurements are challenging due to the large extent of the distribution system, including more than a million miles of distribution mains, more than 60 million service line connections, and thousands of metering and regulating stations operating under varying gas pressures and other conditions.
 - Recent measurements of elevated methane concentrations in the air above streets in Boston, San Francisco and Los Angeles strongly suggest distribution system leakages. Additional measurements are needed to estimate leak rates based on such measurements.

Report in Brief

Natural gas use in the U.S. grew by 25 percent from 2007 to 2012. Within the power sector natural gas use grew from 30 percent to 36 percent of all gas use. Shale gas produced by hydraulic fracturing has grown especially rapidly, from close to zero a decade ago to about one-third of all gas today. Continued growth is projected, and shale gas could account for half of all gas in another two decades.

As gas production has grown, electricity generated using gas has grown, from less than 19 percent of all electricity in 2005 to more than 30 percent in 2012. During the same period coal electricity fell from 50 percent to 37 percent. Many associate the shift from coal to gas with significant reductions in U.S. greenhouse gas emissions from electricity because of the lower carbon content of natural gas compared to coal and the higher efficiency with which gas can be converted to electricity.

However, the main component of natural gas, methane, is a much stronger global warming gas than CO₂, and any methane leakage to the atmosphere from the natural gas supply system offsets some of the carbon benefit of a coal-to-gas shift. Here we review a wide set of studies that have been published and provide analysis to put the question of methane leakage in perspective: Depending on the rate of methane leakage, how much more climate friendly is natural gas than coal for electricity generation, and how does the rate at which gas is substituted for coal change that answer?

The two most recent official estimates of U.S. methane emissions from the natural gas supply system (published by the EPA) are that from 1.5 percent to 2.2 percent of methane extracted from the ground in 2010 leaked to the atmosphere, from well drilling and production, through gas processing, transmission, and final distribution to end users.

The range in the EPA's leakage estimates and our review of a large number of others' methane leakage estimates indicate significant uncertainty in the leakage rate. The largest uncertainties are for the production and distribution stages. Peer-reviewed studies, which have focused almost exclusively on assessing leakage rates in the first three stages (excluding distribution), have estimated average leakage for these three stages from less than 1 percent up to 4.5

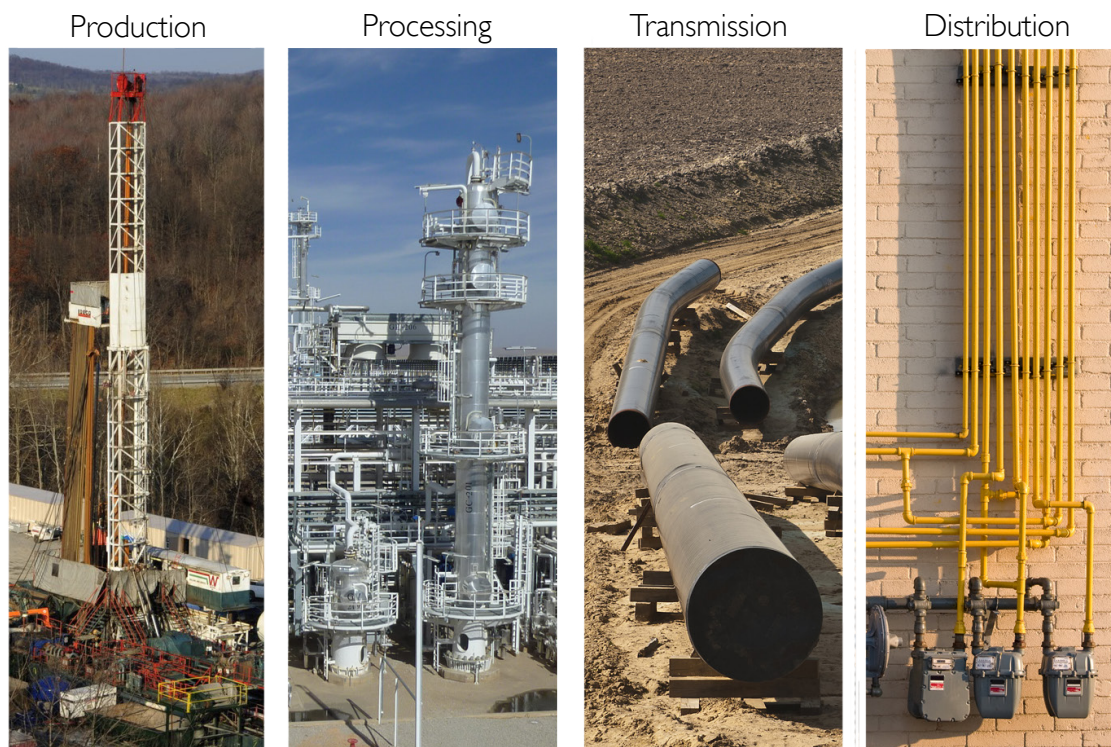

Figure 1. The four stages of the U.S. natural gas supply system.

percent of gas produced, with uncertainty bands extending this range on the high end up to as much as 7 percent. The production stage in most studies accounts for 60 to 85 percent or more of the total estimated leakage across the three stages.

The large uncertainties in leakage estimates arise from the sheer size and diversity of the gas supply system and a lack of sufficient measurements and other data for calculating leak rates.

Gas Production

There are more than half a million gas wells in the U.S., and an average of about 20,000 new wells have been drilled each year over the past several years.

During the production of gas from conventional wells (not hydraulically fractured wells), a significant leakage source is the periodic unloading of liquids that seep into and accumulate in a well over time. A typical gas well undergoes liquids unloading multiple times each year, and the gas that accompanies liquids to the surface when they are unloaded is vented, burned, or diverted to a pipeline. Burning converts methane to CO₂, a less potent greenhouse gas. Estimating the methane vented during liquids unloading requires estimating the number of liquid unloadings that occur each year and the amount of methane vented at each unloading. The EPA made significant revisions in its most recent inventory in estimates of both the number of wells using liquids unloading and the annual emissions from unloadings at such wells. The revisions resulted in a greater than 90 percent reduction in estimated liquids unloading emissions between EPA's 2012 and 2013 estimates. Such a large adjustment raises questions as to the uncertainties in such estimates. Having confidence in emissions estimates at the national level is challenging because of the large variations in liquids unloading requirements across wells, the differing industry practices for handling the gas streams that accompany liquids unloading, and the lack of measurements.

Average methane leakage rates for conventional gas production based on different studies in the literature range from 0.3 to 2.2 percent of gas produced. The large range reflects a lack of agreement among authors due in part to the poor quality and limited amount of publicly available data.

With shale gas, the largest emissions during production occur during well completion, the process of preparing the well for the start of marketed production. This includes drilling, hydraulic fracturing, and flow back of the fracturing fluid to the surface. In some cases, maintaining gas production requires periodic well re-fracturing, called a workover. Whether the gas that accompanies the flowback fluid to the surface is vented, burned, or captured for sale significantly affects the overall leakage rate. How flowback gas is handled at different wells is not well known, which further contributes to uncertainties in average estimates of well completion emissions.

An additional significant source of uncertainty in methane leakage during production is the amount of gas that a well will produce over its lifetime. This estimated ultimate recovery (EUR) is important because the one-time methane emissions that occur during well completion are allocated across the total expected production from the well to estimate the percentage of gas production that leaks. An appropriate average EUR to use in leakage estimates is difficult to know with confidence because few shale wells have yet operated for their full lifetime. Moreover, it is likely that EUR values for wells in different shale basins will vary by an order of magnitude or more, and wells within the same basin are expected to have variations in EUR of 2 or 3 orders-of-magnitude.

Beginning in 2013, all natural gas producers are required to report data to the EPA on their production practices, and these data are expected to help reduce some of the uncertainties around estimated leakage rates during gas production. In addition, beginning in August 2011, EPA regulations required that methane be either burned or captured during completion of hydraulically fractured wells. Starting in 2015, all hydraulically fractured wells will be required to use "green completion" technologies to capture the methane. The EPA estimates that methane leakage is reduced by 95 percent with a green completion compared with venting of the methane.

The average methane leakage rate for gas production from hydraulically fractured shale wells estimated in different studies ranges from 0.6 to 3.0 percent.

Gas Processing

An estimated 60 percent of gas coming out of wells in the U.S. contain CO₂ and other contaminants at unacceptably high levels for market sale, so this gas must first undergo processing. A gas processing plant is a collection of chemical reactors that strip contaminants, along with a series of electric and engine-driven compressors that move gas through the plants. Most of the methane leakage during gas processing is believed to come from compressor seals and from incomplete gas combustion in the engines. A major EPA-sponsored study published in 1996 reported measured leak rates from more than 100 different emission sources in the natural gas supply system. Measurements included compressors and engines at gas processing plants, on the basis of which representative daily leakage rates were determined. These are the basis for most of the EPA's gas processing emission estimates today. Additionally, when required, CO₂ that originated in the natural gas is separated from the gas during processing and vented to the atmosphere. This is not a methane emission, but contributes to the overall upstream greenhouse gas emissions footprint of natural gas.

Average methane leakage from gas processing is 0.1 to 0.3 percent of the methane produced, based on different studies. Because there is a well-documented number of gas processing facilities – one facility will handle gas from many wells – and because emission factors are based on measurements of compressor and engine leak rates (albeit measurements made nearly two decades ago), the level of confidence in estimates of gas processing methane leakage rates is relatively high. Moreover, based on EPA's estimates, gas processing accounts for the least methane leakage among the four stages in the natural gas supply system, so uncertainties in gas processing estimates are of less significance overall than uncertainties around leakage in other stages.

Gas Transmission

There are more than 300,000 miles of natural gas transmission pipelines in the U.S., some 400 storage reservoirs of varying types, more than 1400 pipeline-gas compressor stations, and thousands of inter-connections to bulk gas users (such as power plants) and distribution networks. Essentially all gas passes through the transmission system, and about half is delivered directly from a transmission line to large customers like power plants. Transmission pipelines are relatively well maintained, given the risks that poor maintenance entails. The EPA estimates that most methane emissions associated with transmission are due to leakage at compressors and from engines that drive compressors.

Most studies estimate that average methane leakage in gas transmission ranges from 0.2 to 0.5 percent of production. Because the number of compressors and engines in the transmission system are relatively well documented and because emission factors are based on leakage measurements (albeit made in the mid-1990s), the level of confidence in estimates of gas transmission leakage is relatively high. However, variations in leakage associated with the large seasonal movements of gas in and out of storage reservoirs was not considered when measurements were made, and this introduces some uncertainties.

Gas Distribution

About half of all gas leaving the transmission system passes through a distribution network before it reaches a residential, commercial, or small industrial user. Next to gas production, the uncertainties in methane leakage estimates are most significant for gas distribution. Aside from EPA estimates, there are few systematic studies of leakage in gas distribution. The uncertainties in estimating distribution leakage arise in part because of the large number and varying vintages of distribution mains (an estimated 1.2 million miles of pipes in the U.S.), the large number of service lines connecting distribution lines to users (more than 60 million), and the large number and variety of metering and pressure-regulating stations found at the interface of transmission and distribution systems and elsewhere within the distribution network.

The EPA's leakage estimates are based on measurements made in the 1996 study mentioned earlier, and nearly half of distribution system leakage is estimated to occur at metering/regulating stations. Leakage from distribution and service pipelines accounts for most of the rest. The EPA assumes there is no leakage on the customer side of gas meters, though at least one recent study has suggested this may not be the case.

More recent measurement-based studies help highlight some of the uncertainties with estimating distribution emissions. One study in Sao Paulo, Brazil, measured leakage rates from distribution mains made of cast iron, pipe material that leaks the most. Cast iron was the standard material for U.S. distribution mains in the 1950s, and there are an estimated 35,000 miles of cast-iron pipe still in everyday use in the U.S. The EPA assumes the annual leakage rate for a mile of cast-iron pipe is 78 times that for an equivalent pipe made of steel, a principal replacement pipe for cast iron. The Brazilian study, based on measurements at more than 900 pipe sections, estimated an annual leakage rate per mile at least three times that assumed by the EPA.

There have not been many assessments of total leakage in distribution systems other than that of the EPA, which estimates leakage of 0.3 percent of production. However, several recent studies have measured elevated methane concentrations above the streets of Boston, San Francisco, and Los Angeles. These concentration measurements cannot be converted into estimates of leak rates without additional companion measurements. Follow-up measurements are in progress. Given the poor quality of available data on methane leaks from the distribution system, such measurements will be essential in reducing the uncertainties in distribution leakage estimates.

Natural Gas System Leakage in Total and Implications for Electricity Generation

Electric power generation is the largest gas-consuming activity in the U.S. When considering natural gas electricity generation, leakage from the production, processing, and transmission stages are important to consider, since nearly all power plants receive gas directly from the transmission system. The EPA has estimated methane leakage across the production, processing, and transmission stages of the U.S. natural gas supply system to be 1.2 percent to 2 percent of production, but our review of other assessments finds leakage estimates ranging from less than 1 percent to 2.6 percent for conventional gas and from 1 percent to 4.5 percent for shale gas. When uncertainties in the individual estimates are included, the range extends to 3.8 percent for conventional gas and 7 percent for shale gas. Our review finds that additional leakage measurements are needed to better understand actual leakage rates.

Absent more certainty about methane leak rates, we can assess global warming impacts of different leak rates to identify important threshold leakage levels. For illustration, we consider gas-fired electricity generation, which has been increasing rapidly in recent years primarily at the expense of coal-fired generation. In 2012, 30 percent of all electricity was generated from gas. Many authors have suggested that displacing existing coal-fired generation with natural gas electricity provides a 50 percent reduction in global warming impact because of the lower carbon content of gas and the higher efficiency with which it can be used to generate electricity. But the claim of a 50 percent reduction ignores the global warming impact of methane leaks and the related fact that the potency of methane as a greenhouse gas is far higher than that of CO₂. On a pound-for-pound basis methane has a global warming potential about 100 times that of CO₂ initially, although over 20- or 100-year timeframes, this reduces to 72 or 25 times.

Taking into consideration the time-dependent global warming potential of methane relative to CO₂, we estimated the potential greenhouse benefits from replacing the electricity generated by a single coal power plant with electricity from natural gas instead. Our analysis indicates that if total methane leakage from the gas supply system were 4 percent of production, this substitution of gas-fired electricity for coal-fired electricity would result in only about a 25 percent climate benefit over the next decade, a 35 percent benefit over a 50-year horizon, and a 41 percent benefit over a century (i.e., less than the often cited 50 percent reduction). At higher methane leak rates, the benefits would be lower over the same time horizons. For a switch from coal to gas to provide any positive climate benefit over any time horizon, methane leakage needs to be 6 percent per year or less, and to achieve a 50 percent or better climate benefit over any time horizon leakage needs to be 1.5 percent or less. This analysis applies to a situation in which a coal plant retires and its electricity output is provided instead by a natural gas plant.

At the national level, one must also consider the rate at which coal plants are substituted by gas plants. Here we consider a scenario in which there is a steady substitution of coal electricity by gas-generated power at some average annual rate over time, assuming the total electricity supplied by gas plus coal remains constant. This has roughly been the situation in the U.S. over the past decade, when coal electricity generation decreased at an average rate of 2.4 percent per year, with generation from natural gas making up most of the reduction. (The rate of reduction in coal generation has been accelerating. It averaged 5.5 percent per year over the last 5 years, and 9.4 percent per year over the past 3 years.)

With a coal-to-gas shift, every year there is more gas-fired electricity produced than the previous year, and the methane leakage associated with each new increment of gas electricity has a warming potency that is initially very high and falls with time. When the global warming potential of each new annual pulse of methane is considered, the impact of shifting from coal to gas is less than for the one-time coal-to-gas conversion considered above.

For example, if existing coal electricity were substituted by gas at 5 percent per year, requiring 59 years to reach 95 percent coal replacement, then in 2050 – 37 years from today – the global warming impact (compared to continued coal use) would be lower by 17 or 41 percent, assuming methane leakage of 5 or 2 percent, respectively (Figure 2). If leakage were 8 percent there would be no global warming benefit from switching to gas for at least 50 years.

The 5 percent per year coal substitution rate assumed in the previous paragraph may be difficult to sustain with the gas supply levels the U.S. Department of Energy currently projects will be available over the next three decades. A more realistic coal substitution rate may be 2.5 percent per year, which will require 118 years to reach 95 percent coal replacement. At this rate, the reduction in global warming potential over the next 37 years relative to continued coal use would be only 12 or 29 percent for methane leakage of 5 or 2 percent, respectively (Figure 2). To achieve better than these levels would require other lower-carbon options, such as reduced electricity consumption and/or increased electricity supply from nuclear, wind, solar, or fossil fuel systems with CO₂ capture and storage to provide some of the substitution in lieu of gas.

This analysis considers no change in leakage rate or in the efficiencies of power generation over time. The benefit of a switch from coal to gas would obviously increase if leakage were reduced and/or natural gas power-generating efficiency increased over time.

In summary, the coal-to-gas transition rate, the changing potency of methane over time, and the methane leakage fraction all significantly affect future global warming. Knowing with greater certainty the level of methane leakage from the natural gas supply system would provide a better understanding of the actual global warming benefits being achieved by shifting from coal to gas.

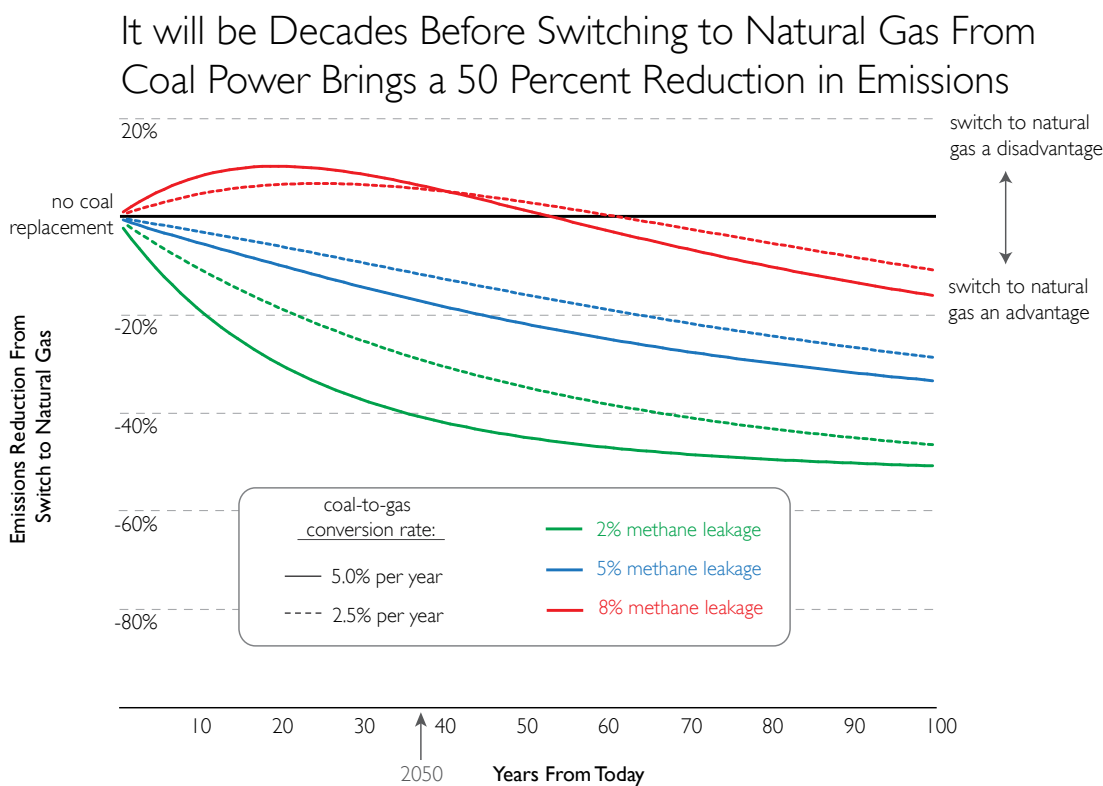

Figure 2. Impact on global warming of shifting existing coal generated electricity to natural gas over time relative to maintaining existing coal generation at current level. The impacts are calculated for two different annual coal-to-gas substitution rates and for three assumed methane leakage rates.

I. Introduction

Natural gas is the second most abundant fossil fuel behind coal, in both the U.S. and the world. At the rate it was used in 2011, the U.S. has an estimated (recoverable) 91-year supply of natural gas. Coal would last 140 years (Table 1). Oil, the most-used fossil fuel in the U.S., would last 36 years.

The estimates of the total amount of natural gas stored under the U.S. increased dramatically in the past decade with the discovery of new forms of unconventional gas, which refers broadly to gas residing in underground formations requiring more than a simple vertical well drilling to extract. Shale, sandstone, carbonate, and coal formations can all trap natural gas, but this gas doesn't flow easily to wells without additional "stimulation".⁴ The production of shale gas, the most recently discovered unconventional gas, is growing rapidly as a consequence of new technology and know-how for horizontal drilling and hydraulic fracturing, or fracking.^a (See Box 1.) An average of more than 2000 new wells per month were drilled from 2005 through 2010 (Figure 3), the majority of which were shale gas wells.

Shale gas accounted for 30 percent of all gas produced in the U.S. in 2011, a share that the U.S.

Department of Energy expects will grow significantly in the decades ahead, along with total gas production (Figure 4). Gas prices in the U.S. fell significantly with the growth in shale gas and this has dramatically increased the use of gas for electric-power generation (Figure 5) at the expense of coal-fired power generation. Coal and natural gas provided 37 percent and 30 percent of U.S. electricity in 2012.⁶ Only five years earlier, these shares were 49 percent for coal and 22 percent for gas.

Using natural gas in place of coal in electricity generation is widely thought to be an important way to reduce the amount of globe-warming CO₂ emitted into the atmosphere, because combustion of natural gas by itself produces much less CO₂ than the combustion of an energy-equivalent amount of coal (Figure 6, left), and natural gas can be converted much more efficiently into electricity than coal, resulting in an even larger difference between combustion-related emissions per kilowatt-hour of electricity generated (Figure 6, right).

When comparing only combustion emissions, natural gas has a clear greenhouse gas emissions advantage over coal. But emissions are also released during fossil fuel extraction and transportation (these are known as the upstream emissions) and these must also be considered to get an accurate picture of the full greenhouse emissions impact of natural gas compared to coal. The upstream plus combustion emissions when considered together are often called the lifecycle emissions.

Table 1. Number of years that estimated recoverable resources of natural gas, petroleum, and coal would last if each are used at the rate that they were consumed in 2011.*

	Years left at 2011 rate of use	
	WORLD*	U.S.**
Conventional Natural Gas	116	42
Unconventional Natural Gas	1021	49
Petroleum	171	36
Coal	2475	140

* Calculated as the average of estimated reserves plus resources from Rogner, et al¹, divided by total global use of gas, petroleum, or coal in 2011 from BP.² The consumption rates in 2011 were 122 exajoules for gas, 170 exajoules for oil, and 156 exajoules for coal. One exajoule is 10¹⁸ joules, or approximately 1 quadrillion BTU (one quad).

** Including Alaska. Calculated from resource estimates and consumption data of EIA.³

^a Horizontal drilling and hydraulic fracturing are also applied to produce gas from some tight sandstone and tight carbonate formations. A key distinction between the term tight gas and shale gas is that the latter is gas that formed and is stored in the shale formation, whereas the former formed external to the formation and migrated into it over time (millions of years).⁴

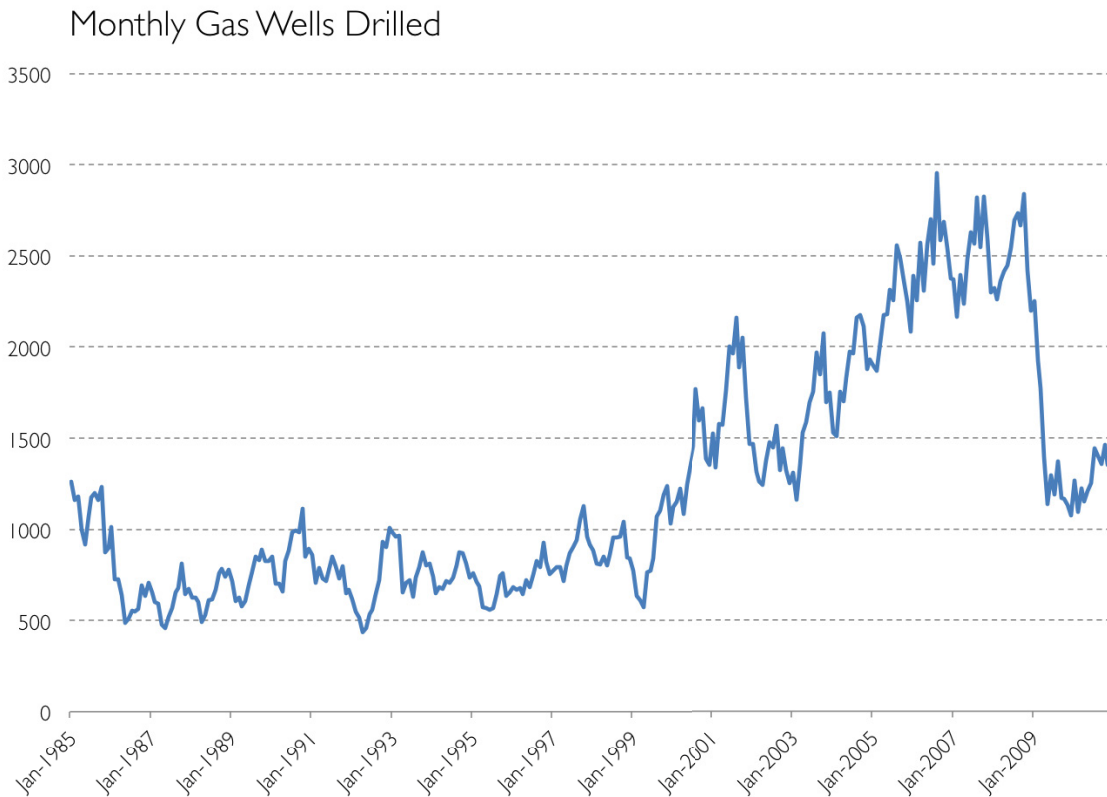

Figure 3. Number of gas wells drilled per month in the U.S.⁵

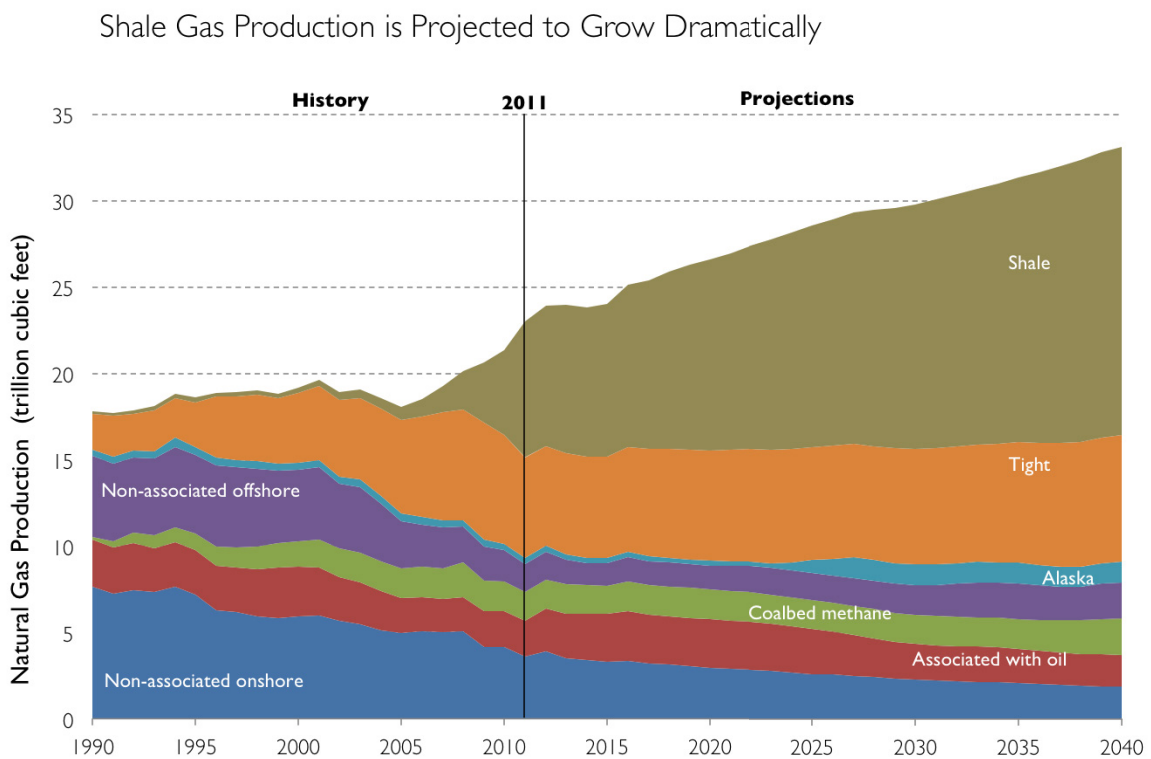

Figure 4. Past and projected U.S. natural gas production (in trillion cubic feet per year). A trillion cubic feet of natural gas contains about one quadrillion BTU (quad), or equivalently about 1 exajoule (EJ) of energy. Source: EIA.⁷

Electricity Generation Is Now the Largest User of Natural Gas

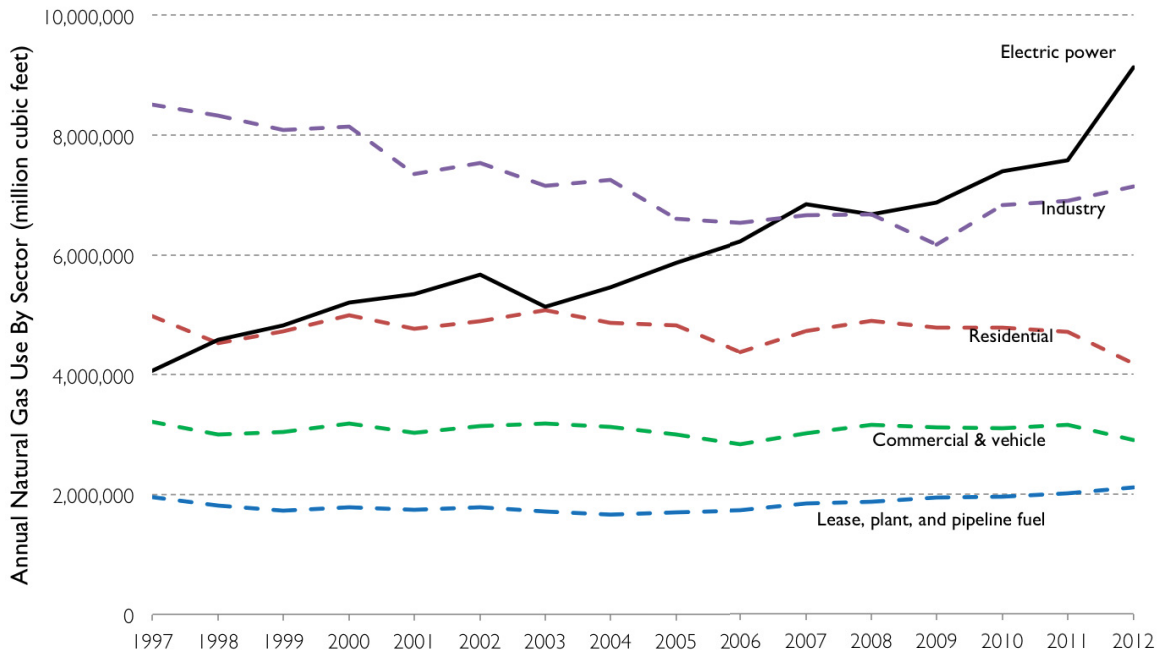

Figure 5. Unlike other sectors, natural gas for electricity generation has been growing since around 1990 and is now the single largest user of natural gas. This graph shows gas use (in million cubic feet per year) by different sectors. Lease, plant, and pipeline fuel refers to natural gas consumed by equipment used to produce and deliver gas to users, such as natural gas engines that drive pipeline compressors. Source: EIA.

Burning Natural Gas Produces Much Less CO₂ Than Burning Coal

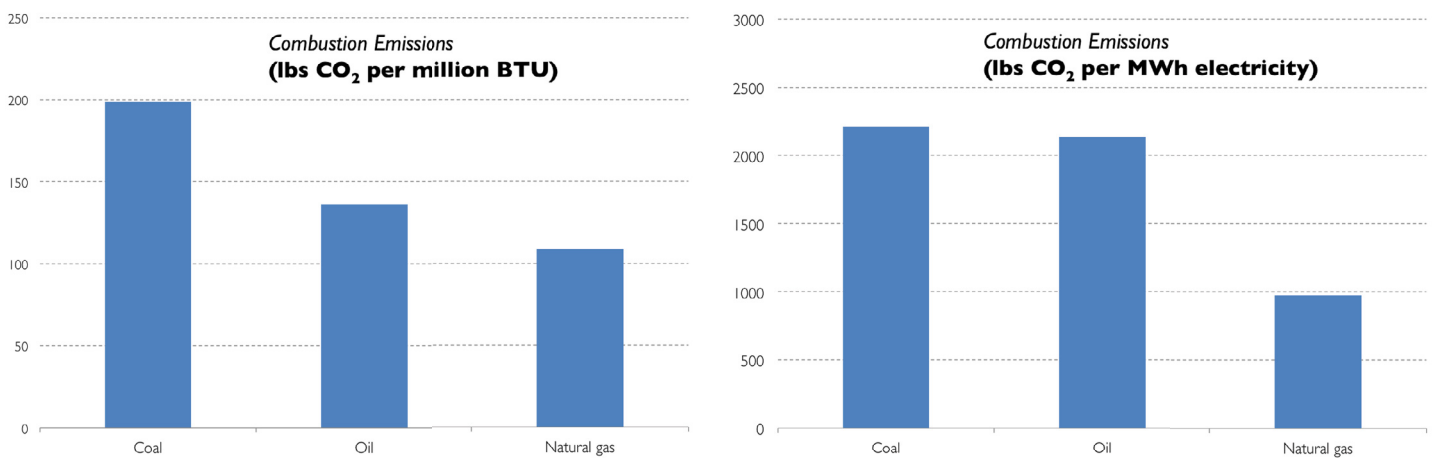

Figure 6. Average emissions by fuel type from combustion of fossil fuels in the U.S. in 2011:⁷ average emissions per million BTU (higher heating value) of fuel consumed (left) and average emissions per kWh of electricity generated (right).

The recent and dramatic appearance of shale gas on the energy scene has raised questions about whether or not lifecycle greenhouse gas emissions for natural gas are as favorable as suggested by the simple comparison of combustion emissions alone. The main constituent of natural gas, methane (CH_4), is a much more powerful greenhouse gas than CO_2 , so small leaks from the natural gas system can have outsized impacts on the overall lifecycle carbon footprint of natural gas. (See Box 2.)

In this report, we review what is known about methane leakage and other greenhouse gas emissions in the full lifecycle of natural gas, including shale gas. The natural gas supply system includes production of raw gas, processing of the raw gas to make it suitable for pipeline transport, transmission of gas in bulk by pipeline (often over long distances), and finally local distribution of the gas to users (Figure 7). The infrastructure is vast, with literally thousands of places where leaks of methane could occur. As of 2011, the U.S. natural gas system

included more than half a million producing wells, several hundred gas processing facilities (Figure 8), hundreds of thousands of miles of gas transmission pipelines (Figure 9) and integrated storage reservoirs (Figure 10), more than a million miles of local distribution mains, and more than 60 million service pipe connections from distribution mains to users. The system delivered on average about 70 billion cubic feet of gas each day to users nationwide in 2012.

We discuss GHG emission estimates of the natural gas system made by the U.S. Environmental Protection Agency (EPA), which annually produces official and detailed estimates of all U.S. greenhouse gas emissions. We then review other, non-EPA estimates, compare these with EPA's numbers, and highlight where the most significant uncertainties lie. We finish with an analysis that puts in perspective the significance of different methane leak rates for the global warming impact of natural gas substituting coal in electricity generation.

Each Stage in the Natural Gas Supply System is a Vast Infrastructure

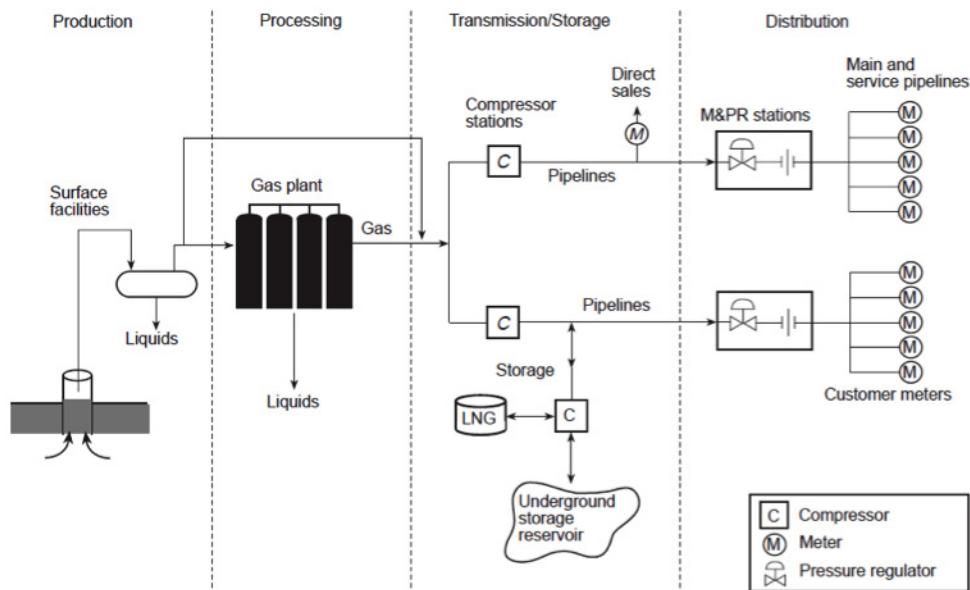

Figure 7. The U.S. natural gas supply system.⁸

There are Hundreds of Natural Gas Processing Plants in the Country

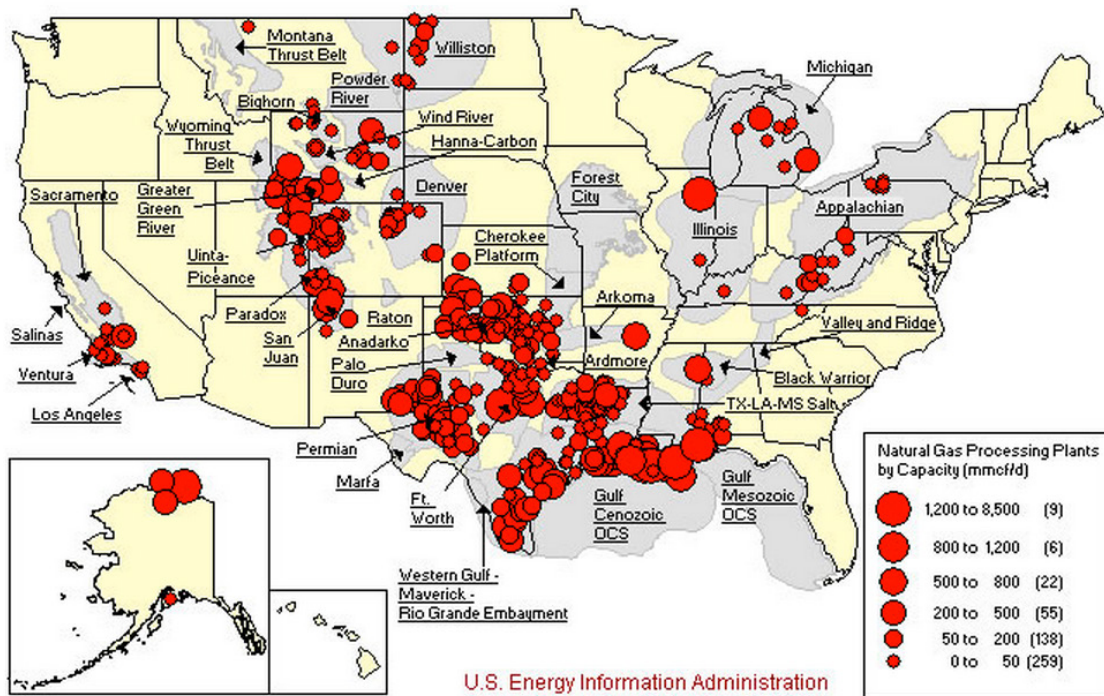

Figure 8. U.S. natural gas processing plants.⁹

Hundreds of Thousands of Miles of Gas Transmission Pipelines Cover the U.S.

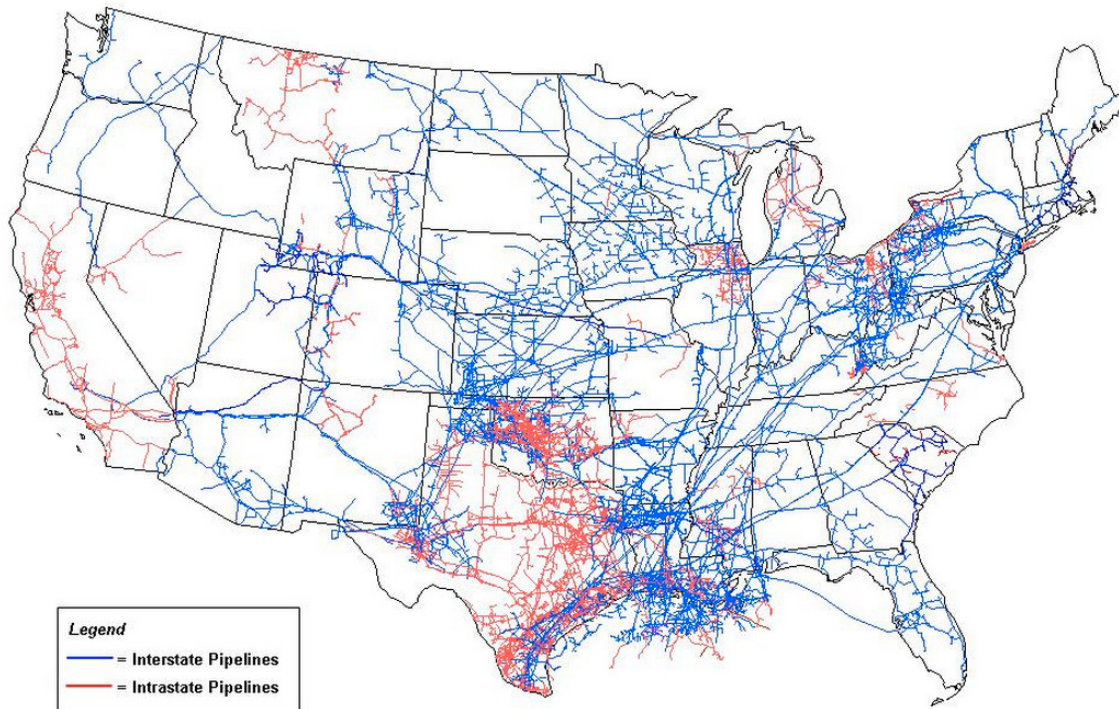
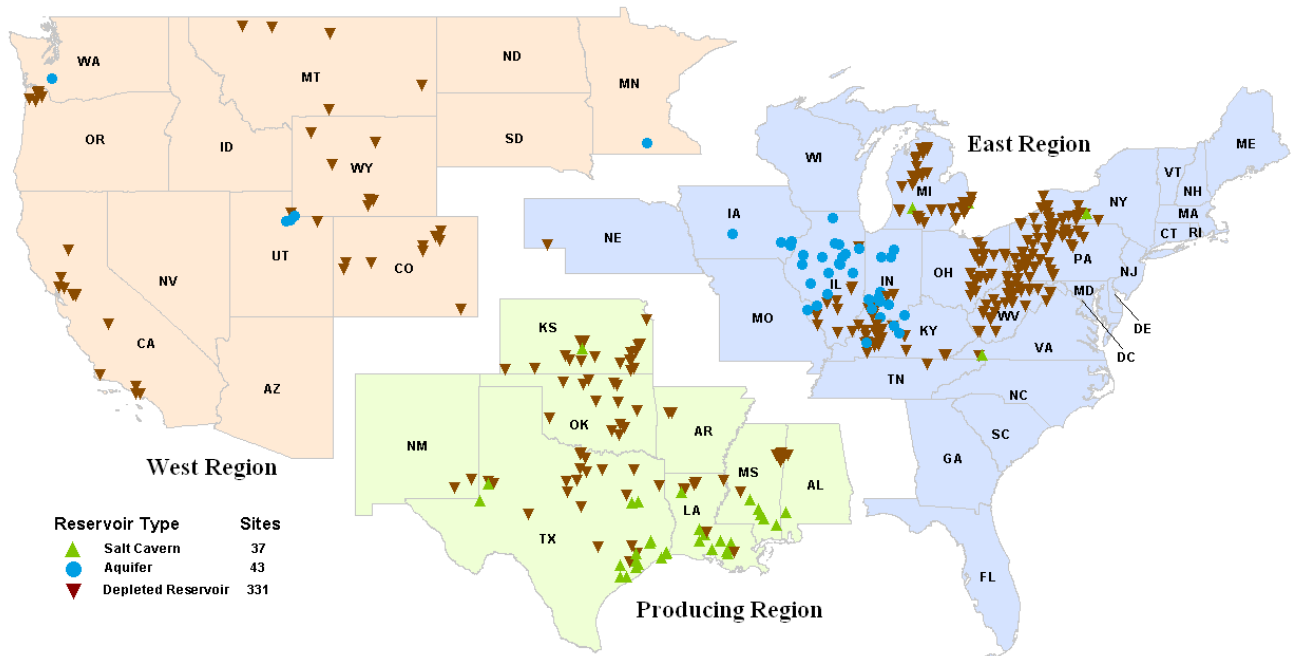

Figure 9. The U.S. natural gas transmission system (as of 2009).¹⁰

Natural Gas Storage Facilities Exist Across the Country

U.S. Lower 48 Underground Natural Gas Storage Facilities, by Type (December 31, 2010)



Note: Locations of storage facilities presented in the map are approximate. Some symbols representing storage facilities may overlap.
 Source: U.S. Energy Information Administration, Form EIA-191A, "Annual Underground Gas Storage Report"

Figure 10. U.S. natural gas storage facilities.¹¹

Table 2. Mean estimate by the U.S. Geological Survey of undiscovered technically recoverable shale gas resources by basin. ¹³

	Trillion cubic feet*
Gulf Coast	124.896
Haynesville Sabine	60.734
Eagle Ford	50.219
Maverick Basin Pearsall	8.817
Mid-Bossier Sabine	5.126
Appalachian Basin	88.146
Interior Marcellus	81.374
Northwestern Ohio	2.654
Western Margin Marcellus	2.059
Devonian	1.294
Foldbelt Marcellus	0.765
Alaska North Slope	40.589
Shublik	38.405
Brookian	2.184
Permian Basin	35.130
Delaware-Pecos Basins Barnett	17.203
Delaware-Pecos Basins Woodford	15.105
Midland Basin Woodward-Barnett	2.822
Arkoma Basin	26.670
Woodford	10.678
Fayetteville-High Gamma Ray Depocenter	9.070
Fayetteville Western Arkansas	4.170
Chattanooga	1.617
Caney	1.135
Bend Arch-Forth Worth Basin	26.229
Greater Newark East Frac-Barrier	14.659
Extended Continuous Barnett	11.570
Andarko Basin	22.823
Woodford	15.973
Thirteen Finger Limestone-Atoka	6.850
Paradox Basin	11.020
Gothic, Chimney Rock, Hovenweep	6.490
Cane Creek	4.530
Michigan Basin (Devonian Antrim)	7.475
Illinois Basin (Devonian-Mississippian New Albany)	3.792
Denver Basin (Niobrara Chalk)	0.984
Total	376.734

* One trillion cubic feet of gas contains about one quadrillion BTU (one quad).

Seven States Accounted for 90 Percent of Shale Gas Production in 2011

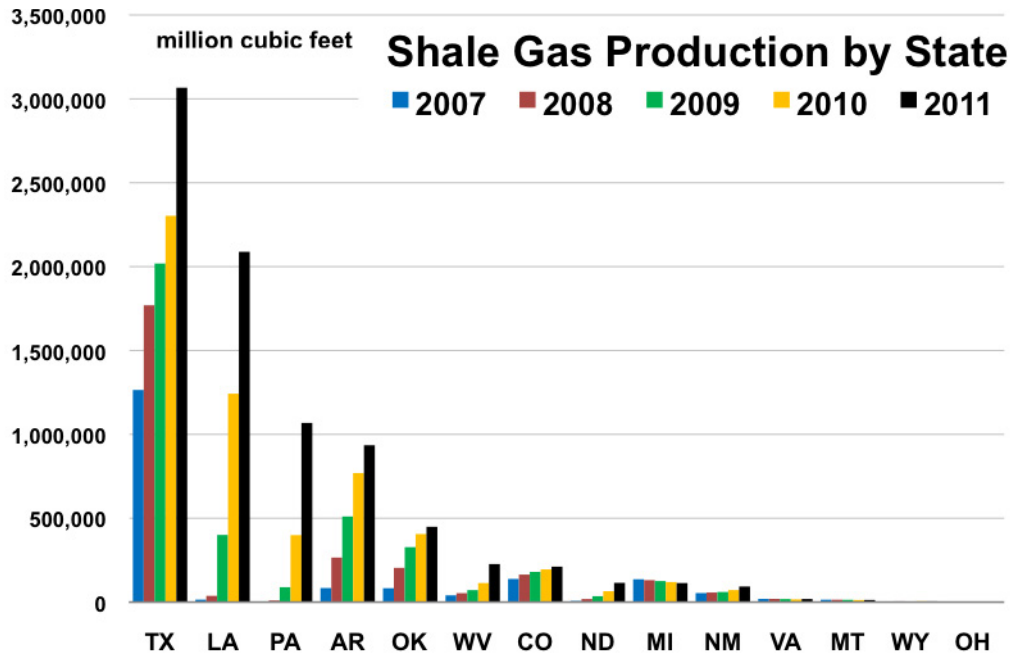

Figure 12. Shale gas production in the U.S. has grown rapidly.¹⁴

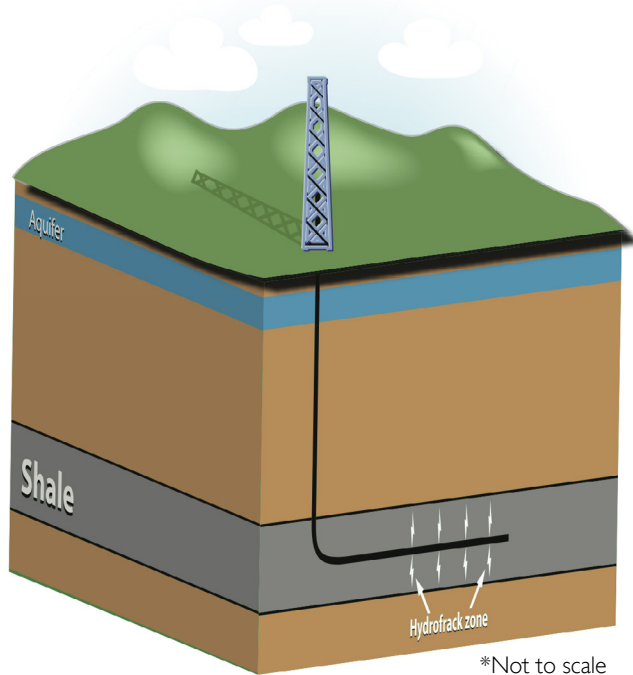

Figure 13. Hydraulic fracturing combined with horizontal drilling allows accessing more of a thin shale formation.

The existence of shale gas has been known for decades, but only with the development of hydraulic fracturing and horizontal drilling techniques in the mid-1990s did it become economically viable to produce. Hydraulic fracturing involves injecting a “fracking fluid” (water plus a “proppant” – typically sand – and small amounts of chemicals) at sufficiently high pressure into a well bore to crack the surrounding rock, creating fissures that can extend several hundred feet from the well bore. As the fluid flows back to the surface before the start of gas production, the proppant stays behind and keeps the fissures propped open allowing gas to escape to travel to the well bore.

“Fracking” was originally developed for use in vertically drilled wells, but shale gas production only began in earnest with the development of horizontal drilling, which when combined with fracking, enables access to much more of the volume of the thin, but laterally expansive shale formations (Figure 13). State-of-the art shale gas wells have horizontal holes extending 3000 feet or more from the vertical hole. Additionally, multiple horizontal holes are typically drilled from a single well pad, reducing overall drilling costs and enabling access to much more of a shale formation from a small area on the surface.

Box 2: The Global Warming Potential of Methane

Some molecules in the atmosphere allow solar energy to pass through to the earth's surface, but absorb energy radiated back from the earth and re-radiate that energy back to the surface, thereby making the earth's surface warmer than it would be without these "greenhouse gases" in the atmosphere. Two of the most important global warming molecules are carbon dioxide (CO₂) and methane (CH₄). Each has different global warming behavior and the term "Global Warming Potential" (GWP) is used to characterize their warming power. For convenience, the GWP of one pound (or kilogram) of CO₂ is defined to be equal to one, and GWP's of other gases are defined relative to the warming effect of CO₂.

The GWP of methane is determined by three factors: the warming properties of the methane molecule itself ("direct radiative forcing"), the warming resulting from interactions between methane and other molecules in the atmosphere ("indirect forcing"), and the effective lifetime of methane in the atmosphere. Considering the first two factors, the warming impact of one kilogram of methane is 102 times that of one kilogram of CO₂, according to the Intergovernmental Panel on Climate Change (IPCC). The third factor is relevant because the carbon in a molecule of methane emitted into the atmosphere will eventually react with oxygen and be converted to CO₂. The characteristic lifetime for methane molecules in the atmosphere is 12 years.¹⁵ The lifetime for a CO₂ molecule in the atmosphere is far longer than this.

Because of the different lifetimes of CH₄ and CO₂, the GWP of CH₄ depends on the time period over which the impact is assessed. The longer the time after being emitted, the lower the GWP (Figure 14).

Thus, the timeframe used for any particular analysis is important. A shorter timeframe may be appropriate for evaluating GWP if the focus is on short-term warming effects or if the speed of potential climate change is of more interest than the eventual magnitude of change in the longer term. A longer horizon would be more appropriate when the interest is in changes that will be expressed more in the longer term, such as significant increase in sea level.

GWP values for methane that are considered the consensus of the climate science community are those published in the Assessment Reports of the Intergovernmental Panel on Climate Change (IPCC), Table 3. As understanding of the science of global warming has improved, the estimate of methane's GWP has increased. For example, the IPCC's Second Assessment Report and Third Assessment Report gave a 100-year GWP of 21 for methane, compared with 25 in the Fourth Assessment Report. More recent analysis has suggested that the GWP may be higher still,¹⁶ but pending publication of the IPCC's Fifth Assessment Report (expected in 2013/2014), the scientific consensus GWP values are those in Table 3. Most analysts use the 100-year GWP to convert methane emissions into equivalent CO₂ emissions, since this is the time frame within which significant climate changes are expected to materialize, given current trends in emissions. Some analyses use a 20-year GWP, arguing that short-term effects are significant and demand significant near-term action to reduce emissions.¹⁷ Alvarez et al.¹⁸ suggest that varying time frames for assessing GWP may be useful. The utility of this approach is illustrated in Section 4 of this report.

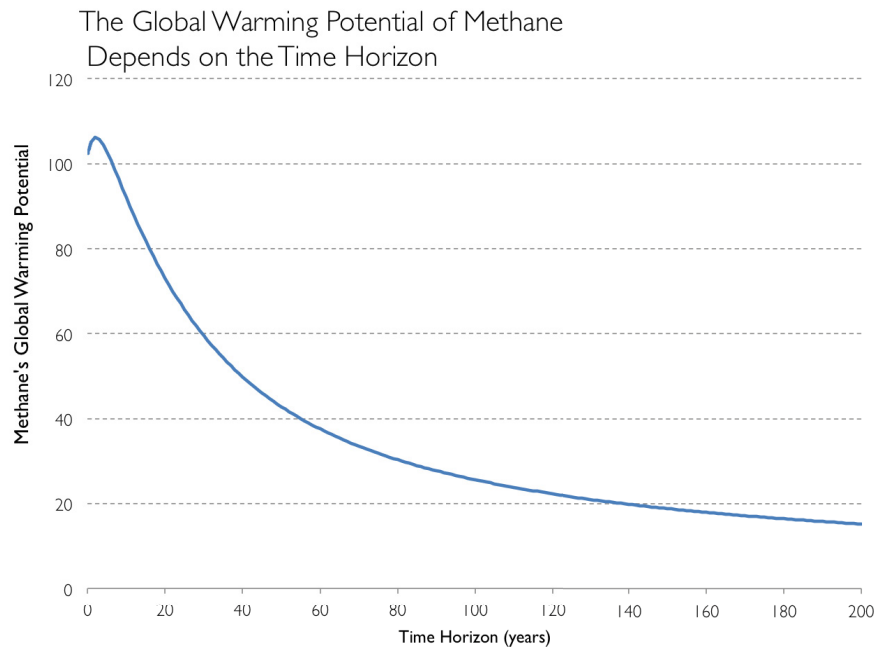

Figure 14. The global warming potential (GWP) of methane relative to CO₂ for a pulse emission at time zero. This assumes a characteristic lifetime in the atmosphere of 12 years for methane and a lifetime for CO₂ as predicted by the Bern carbon cycle model.¹⁵ (See Alvarez et al.¹⁸)

Table 3. The global warming potential for methane falls as the time horizon for its evaluation grows.¹⁵ A 20-year GWP of 72 for methane means that 1 kilogram of methane gas in the atmosphere will cause the equivalent warming of 72 kilograms of CO₂ over a 20 year period. The GWP values here are consistent with those shown in Figure 14.

	20-year GWP	100-year GWP	500-year GWP
GWP of CH ₄ (methane)	72	25	7.6

2. EPA Estimates of GHG Emissions from the Natural Gas Supply System

Official estimates of U.S. greenhouse gas emissions since 1990 are published each year by the Environmental Protection Agency in its so-called Emissions Inventory¹⁹. The EPA recently released its 2013 inventory²⁰, reflecting estimates through 2011. Our discussion here also includes detail drawn from the 2012 inventory²¹, reflecting estimates through 2010. We note key changes in methodology and results between the 2012 and 2013 inventories.

The EPA's estimate of total U.S. greenhouse gas (GHG) emissions in the 2012 inventory are shown in Figure 15 in terra-grams (Tg, or millions of metric tons) of CO₂ equivalent per year.^b Nearly 80 percent of emissions are as CO₂ released from burning fossil fuels.

Methane leakage from the natural gas supply system also contributes^c. In the 2012 inventory, EPA estimated that 10 percent of all GHG emissions in 2010 (in CO₂-equivalent terms) was methane, with leaks in the natural gas supply system accounting for one third of this, or 215 million metric tons of CO₂-equivalent (Figure 16). These methane emissions from the natural gas supply system correspond to 2.2 percent of methane extracted from the ground (as natural gas) in the U.S. in 2010^d. The EPA adjusted this estimate significantly downward (to 144 million metric tons of CO₂-equivalent in 2010) in its 2013 inventory, corresponding to an estimated methane leakage rate in 2010 of 1.5 percent. This large adjustment from one EPA inventory to the next hints at the uncertainties involved in estimating the national methane leakage rate.

The EPA develops its emission estimates using a wide variety of data sources and by applying a multitude of assumptions. (See Box 3). EPA's estimated methane emissions in 2010 from the natural gas system are summarized in Table 4, as reported in the 2012 and 2013 inventories.

Methane was an Estimated 10 Percent of U.S. Greenhouse Gas Emissions in 2010

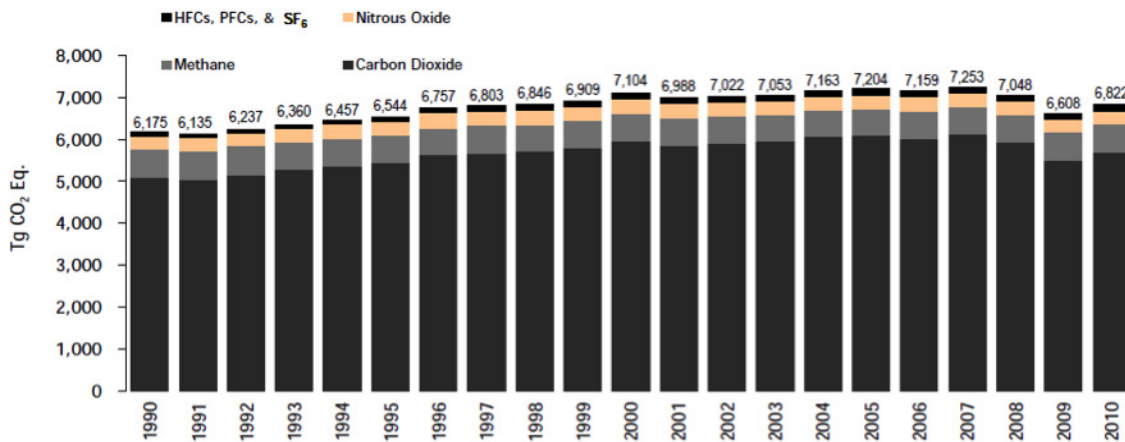

Figure 15. U.S. greenhouse gas emissions as estimated by the Environmental Protection Agency.²¹

^b The EPA inventories use 100-year global warming potentials (GWPs) for non-CO₂ gases taken from the *Third Assessment Report* (1996) of the Intergovernmental Panel on Climate Change (IPCC), not from the most recent (2007) IPCC Assessment. The methane GWP value used by EPA in this inventory is 21. See Box 2 for discussion of GWP.

^c Some naturally-occurring underground CO₂ is also vented to the atmosphere in the course of producing, processing, and transporting natural gas. EPA estimates these are much less one-tenth of one percent of the CO₂-equivalent emissions of methane.²³

^d U.S. natural gas consumption in 2010 was 24.1 trillion standard cubic feet according to the U.S. Energy Information Administration. Assuming the methane fraction in this gas was 93.4 percent, the value assumed by EPA in its emissions inventory,²³ and taking into account the fact that one standard cubic foot (scf) of methane contains 20.23 grams (or 20.23 metric tons per million scf), the total methane consumed (as natural gas) was 455 million metric tons. Considering a GWP of 21 for methane (as the EPA does), this is 9,556 million metric tons of CO₂-equivalent. The ratio of 215 (Table 4) to 9,556 gives a leakage estimate of 2.25 percent of methane consumed. The leakage as a fraction of methane extracted from the ground is $L = 1 - \frac{1}{(1+x)}$ where x is the leakage expressed as a fraction of methane consumption. For x = 0.0225, or L = 0.0220, or 2.2%.

Leaks in the Natural Gas System are Estimated to be One Third of Methane Emissions

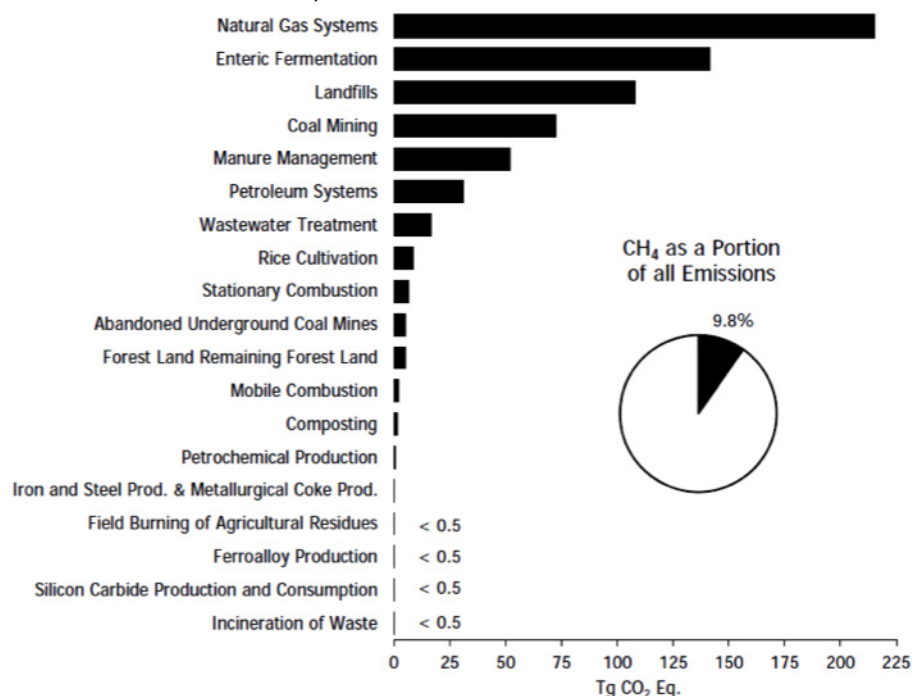

Figure 16. U.S. methane emissions in 2010 (in million metric tons of CO₂ equivalents) as estimated by the Environmental Protection Agency.²¹

Table 4. EPA estimates of methane emissions in 2010 from the natural gas system in units of million metric tons of CO₂-equivalent (for a methane GWP of 21). Figures are from the 2012²² inventory and the 2013 inventory.²⁰

	2012 Inventory	2013 Inventory
	million metric tons of CO ₂ -equivalent	
Natural Gas Production	126.0	57.2
Liquids unloading	85.7	5.4
Pneumatic device vents	12.8	
Gas engines	5.6	
Shallow water gas platforms	5.6	
Completions and workovers with hydraulic fracturing	3.8	16.7
Other production sources	12.5	
Natural Gas Processing	17.1	16.5
Reciprocating compressors	8.3	
Centrifugal compressors (wet seals)	4.9	
Gas engines	3.5	
Other processing sources	0.3	
Natural Gas Transmission and Storage	43.8	41.6
Centrifugal compressors (wet seals) (transmission)	15.7	
Reciprocating compressors (transmission)	12.8	
Engines (transmission)	4.7	
Reciprocating compressors (storage)	3.7	
Liquefied natural gas (LNG) systems	1.9	
Other transmission and storage sources	5.0	
Natural Gas Distribution	28.5	28.3
Meter/regulator (at city gates)	12.5	
Leaks from main distribution pipelines	9.3	
Leaks from service pipelines connected mains and users' meters	4.3	
Other distribution sources	2.4	
Total Natural Gas System (excluding end-use combustion)	215.4	143.6

Box 3: EPA’s Methodologies for Estimating Methane Leakage from the Natural Gas Supply System

EPA arrives at most of the numbers in Table 4 using a “bottom-up” approach, which refers to estimating the emissions for a piece of equipment or process in the natural gas system as the product of an “emissions factor” and the estimated number of times this activity is repeated across the country each year. This is done for many different activities and the results are added up.²³ As an example, for reciprocating compressors used at gas processing plants (see Table 4), EPA estimated (for the 2012 inventory) that the total number of compressors was 5,028 in 2010 and that on average each compressor had an emission factor (leakage of natural gas to the atmosphere) of 15,205 cubic feet per day. Actual emissions per day will vary from one compressor to another²⁴, but the objective of the EPA inventory is to estimate emissions at a national level so an average emission factor is adopted. Multiplying the activity level (e.g., number of compressors) by the emission factor, by 365 days per year, and by the assumed methane fraction in the natural gas (which varies by region in the production and processing steps) gives the total annual estimated cubic feet of methane leaked from reciprocating compressors at gas processing plants in 2010. The EPA converts cubic feet per year to grams per year for purposes of reporting in the inventory. (A standard cubic foot of methane contains 20.2 grams.)

Many of EPA’s emission factors were developed from a large measurement-based study of the natural gas system done in the mid-1990s.²⁵ Some of the factors have been updated since then.

For some activities, EPA adjusts its emissions estimates to account for various factors that lead to lower estimated emissions than when using default emission factors. For example, industry partners in EPA’s Natural Gas STAR Program²⁶ use various technologies to lower emissions. In its 2012 inventory, EPA adjusted its national estimate of emissions to account for reductions by the STAR Program partners. As another example, some state regulations require the use of certain technologies to avoid venting of methane in parts of the natural gas system. The EPA adjusts

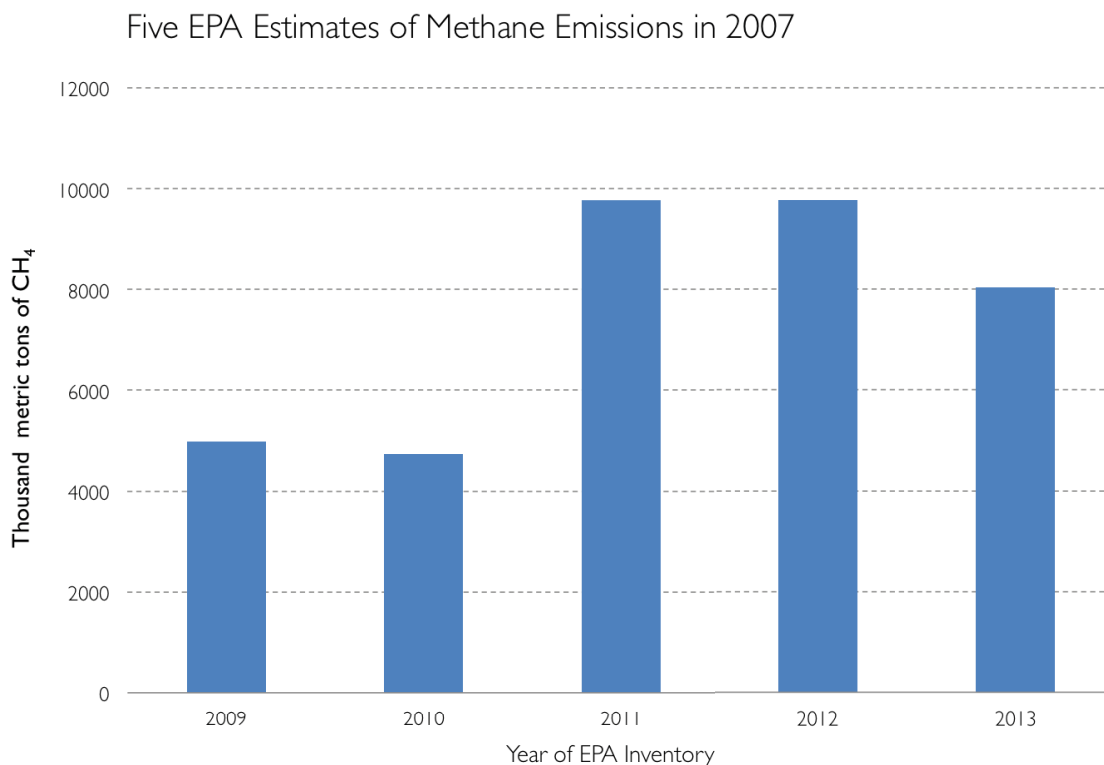

Figure 17. Methane emissions from the natural gas supply system for 2007, as estimated in five different EPA Emission Inventories. Differences in data sources and methodologies account for the differences in estimated emissions.²⁷

its national estimates to account for the reduced emissions that are assumed to have been achieved in such states. For example, some states require gas wells created by hydraulic fracturing to use technology that eliminates venting of methane during well drilling and fracturing. In its 2012 inventory the EPA cites the example of Wyoming as having such regulations.²³ For its 2012 inventory, EPA estimated that in 2010 approximately 51 percent of all gas wells that were hydraulically fractured in the U.S. were in Wyoming. Accordingly, the 2012 inventory assumes that 51 percent of the estimated total number of hydraulically fractured gas wells in the U.S. had essentially no emissions associated with hydraulic fracturing. The 2013 inventory includes major changes in these assumptions, contributing to a significant increase in estimated emissions associated with hydraulically fractured wells (Table 4).

Completing the emissions inventory involves a massive effort on EPA's part, but is not without uncertainties. To help address these, EPA is continually evaluating and modifying its sources and assumptions in an effort to improve the accuracy of its estimates. When modifications are introduced into the estimation methodology, emissions estimates for all prior years (back to 1990) are revised to maintain a consistent set of estimates over time. These modifications sometimes result in large revisions in prior estimates. This is illustrated in Figure 17, which shows estimates of emissions from the natural gas system for a single year (2007) as made in five successive inventories. In its 2011 inventory, EPA made major adjustments in its data and methodologies from the prior year, resulting in a doubling in the estimate of methane emissions. No changes were made in the methodology for the inventory published in 2012, but changes in the 2013 inventory then resulted in a drop in emissions of nearly 20 percent.

2.1 Gas Production

Among the four stages that constitute the natural gas supply system (Figure 7), the production phase contributes the largest fraction of emissions in EPA's inventory (Table 4). It is also the stage for which the largest changes were made from the 2012 inventory to the 2013 inventory. Within the production phase, "liquids unloading" was the largest contributor in the 2012 inventory, but shrank by more than 90 percent in the 2013 inventory (Table 4). The category "completions and workovers with hydraulic fracturing" was the smallest contributor to production emissions in the 2012 inventory, but was more than quadrupled into the largest contributor in the 2013 inventory.

Liquids unloading refers to the removal of fluids (largely water) that accumulate in the well bore over time at a gas producing well. The fluids must be removed to maintain gas flow, and during this process, methane entrained with the fluids can be released to the atmosphere. Conventional gas wells tend to require more liquids unloading than shale gas wells due to differences in underground geology. From the 2012 to 2013 inventory EPA adjusted many of the assumptions used to estimate liquids unloading, including both the number of wells that use liquids unloading and the amount of methane emitted per unloading. Important considerations in the latter include the number of times each year that the average well is unloaded,

the average volume of gas that is entrained with the liquids upon unloading (which varies by region), and the extent to which the entrained gas is captured for flaring (burning)^e or for sale.²⁸



A shale gas operation in Greene County, PA. (Nov 2010).
Credit: Mark Schmerling via FracTracker.org.

^e One pound of methane vented to the atmosphere has a GWP of 25, considering a 100-yr time horizon (see Box 2). If instead the 1 lb of methane were burned, 2.75 lbs of CO₂ would be produced. This amount of CO₂ has a GWP of 2.75. In this comparison, flaring methane instead of venting it reduces the global warming impact of the emission by a factor of 9.

Well completion refers to the process of finishing the creating of a shale gas well (including hydraulic fracturing) such that it can begin producing saleable gas. A workover is the re-fracturing of a shale gas well to maintain its productivity at an acceptable level. Different wells require different numbers of workovers during their producing life, with some wells not requiring any workovers. With hydraulic fracturing, before gas can flow freely to the surface, there is a fracking fluid flowback period (typically lasting several days) during which a substantial portion of the injected fluid returns to the surface, bringing some amount of gas with it. During the flowback period, if gas that surfaces with the returning fluid is not captured (for flaring or for sale) methane is released to the atmosphere. In the 2013 inventory, well completion and workover emissions more than quadrupled from the 2012 inventory primarily because of an increase in the estimate of the number of wells that were hydraulically fractured and a decrease in the assumed percentage of wells using “green completions” – technology that is employed at some wells to eliminate most well-completion emissions.

2.2 Gas Processing

About 60 percent of all natural gas withdrawn from the ground in the U.S. each year undergoes processing^f to make it suitable for entry into the gas transmission system.²⁹ Processing is estimated to account for the smallest contribution to methane emissions among the four stages of the natural gas system (Table 4).



Natural gas processing plant

Some 97 percent of methane emissions estimated to occur during gas processing are the result of leaks from compressors and gas-fired engines. (Gas-fired engines are used to drive reciprocating compressors. Incomplete combustion of gas in engines results in methane emissions.) The EPA estimates emissions based on the number of compressors and engines in use and an emissions factor (scf methane per day) for each. The 1990s EPA-sponsored study mentioned earlier²⁵ determined the emission factors and the number of compressors and engines operating in 1992. EPA's inventories for subsequent years use the same emission factors, and the number of compressors and engines is estimated by scaling the 1992 counts of these by the ratio of gas produced in the inventory year to the gas produced in 1992.

2.3 Gas Transmission and Storage

The natural gas pipeline transmission system in the U.S. includes more than 305,000 miles of pipe, some 400 storage reservoirs, over 1400 compressor stations (Figure 18) each usually with multiple compressors, and thousands of inter-connections to bulk gas users (such as power plants) and to distribution pipeline



Natural gas transmission lines

^f Processing typically removes “condensates” (water and hydrocarbon liquids), “acid gases” (H_2S , CO_2 , and others), and sometimes nitrogen. On average the volume of gas after processing is 7 percent or 8 percent less than before processing.

Compression Stations Exist Throughout the Natural Gas Transmission System

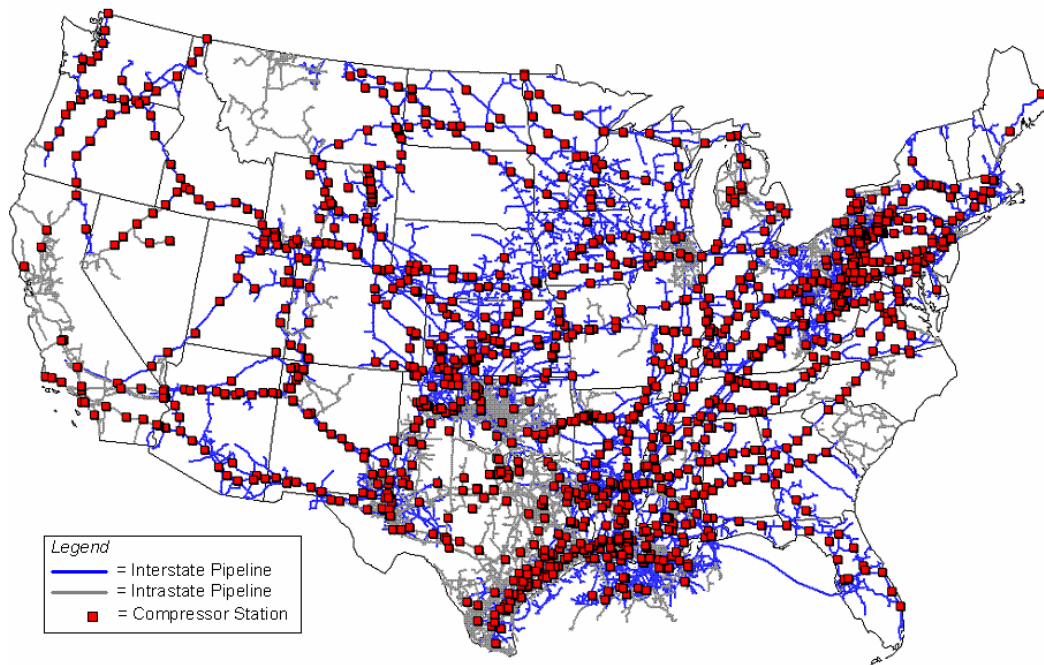

Figure 18. There are more than 1400 compressor stations in the U.S. natural gas transmission pipeline system.³⁰

systems. The EPA estimates that most emissions from the transmission and storage stage come from compressors and engines, with only a small contribution from pipeline leakage (Table 4). Emissions are estimated using emission factors (e.g., scf/mile/yr for pipeline leaks or scf/day for compressor leaks), pipeline mileage, and equipment counts based largely on measurements made in the 1990s.²⁵ Variations in leakage associated with the large seasonal movements of gas in and out of storage reservoirs were not considered when measurements were made, and this may introduce some uncertainty.

2.4 Gas Distribution

More than 1,500 companies manage the distribution of natural gas to about 70 million customers.³¹ The EPA's estimate of methane emissions from gas distribution are for local pipeline distribution systems (an estimated 1.2 million miles of pipe) that are fed by the main transmission pipelines and through which the majority of customers receive their gas. (This excludes most electric power plants and about half of large industrial customers, which are connected directly to a main transmission pipeline and account for perhaps

half of all gas used.⁸) A gas-distribution system includes stations where gas is metered and pressure-regulated

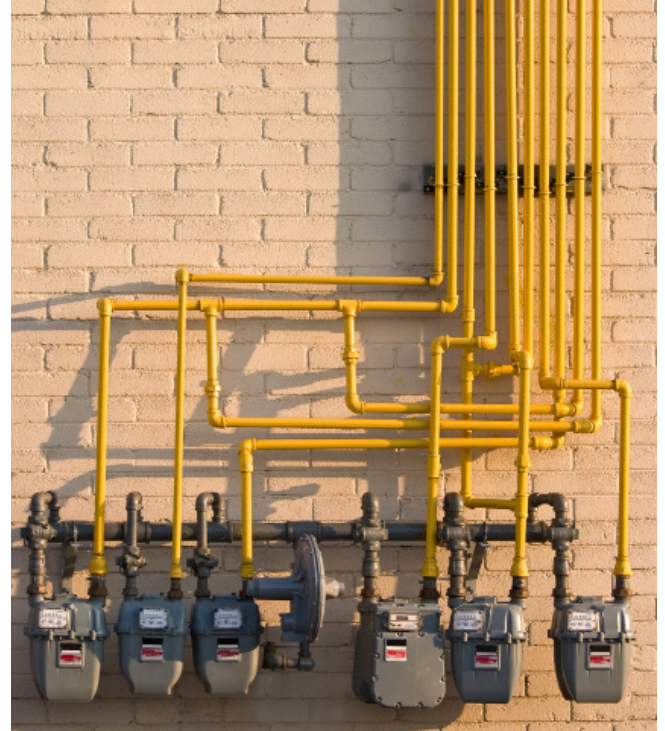

Natural gas meters in the distribution system.

⁸ In 2012, 36 percent of all gas used for energy was used in electric power generation and 33 percent was used in industry. Assuming all of the gas used for electric power and half of the gas used by industry was delivered via transmission pipelines, then approximately half of all gas used in the U.S. was delivered to users via transmission pipeline.

as it is transferred from a transmission line into a distribution network. It also includes the distribution pipelines, “services” (the pipe connecting a customer to a distribution main), and customer meters. The EPA estimates there are more than 63 million service connections in total, and it assumes no leakage occurs after the customer meter.

In the EPA 2012 inventory, the most significant leakage of methane is at the metering/regulating stations (Table 4). The EPA differentiates ten different station types according to function (metering and/or regulating) and the pressure of gas they each handle, and assigns a different emissions factor to each (ranging from 0.09 to 179.8 scf per station per year, based on measurements made in the 1990s²⁵). The emissions factor for each type of station is multiplied by the estimated number of that type of station in operation in that year.

Leakage from distribution and service pipelines account for most of the rest of the estimated methane emissions from the distribution system. This leakage is calculated according to pipe type – cast iron, unprotected steel, protected steel, plastic, and copper – using a different emission factor for each type (in scf per mile per year) and service line (in scf per service per year). In the EPA inventory, cast-iron and unprotected

steel pipes are assumed to have high leak rates, based on measurements made in the 1990s (Table 5)^h. The inventory also estimates the number of miles of each type of pipe in the distribution system and the number of each type of service connection to customers based on data from the Pipeline and Hazardous Materials Safety Association (PHMSA)³².

Table 5. Pipeline methane emission factors and pipeline mileage in EPA's 2013 inventory.²⁰

	Annual Leak Rate (scf/mile)	Miles of Pipe
Distribution mains		
Cast iron	239,000	33,586
Unprotected Steel	110,000	64,092
Plastic	9,910	645,102
Protected steel	3,070	488,265
Transmission pipelines	566	304,606

^h Protected steel refers to carbon steel pipes equipped with a special material coating or with cathodic protection to limit corrosion that can lead to leakage. (Cathodic protection involves the use of electrochemistry principles.) The use of cast iron and unprotected steel pipes, which are susceptible to corrosion, is declining. Nevertheless, there are still an estimated 100,000 miles of distribution pipe made of cast iron or unprotected steel and more than 4.2 million unprotected steel service lines still in use.²³

3. Other Estimates of GHG Emissions from the Natural Gas Supply System

When the EPA made relatively large methodology adjustments in its 2011 inventory (Figure 17), they included a provision to separately calculate emissions from the production of shale gas and conventional gas. This adjustment, together with the growing importance of shale gas in the U.S. supply (Box 1), led others to develop greenhouse gas emission estimates for natural gas. Many technical reports³³⁻⁴² and peer-reviewed journal papers^{17,43-51} have appeared, with emissions estimates varying from one to the next.

All of the published analyses have been made using methodologies similar to the bottom-up approach used in the EPA inventory calculations, but each study varies in its input assumptions. Because of the diversity of natural gas basin geologies, the many steps involved in the natural gas system, the variety of technologies and industry practices used, and, perhaps most importantly, the lack of measured emissions data, a large number of assumptions must be made to estimate overall emissions. As a consequence, different authors come to different conclusions about the magnitude of upstream GHG emissions. For example, some conclude that upstream emissions per unit energy for shale gas are higher than for conventional gas^{17,46} and others conclude the opposite.^{33,43,49} Many of the authors rely on the same two information sources for many of their input assumptions,^{52,53} leaving just a few key assumptions mainly responsible for differences among results.

Table 6. Estimates of upstream methane and CO₂ emissions for conventional gas and shale gas, with comparison to EPA estimates for the natural gas supply system as a whole.* (Emissions from gas distribution are not included here.)

UPSTREAM EMISSIONS	Jiang ⁴⁷		NETL ³³		Hultman ⁴⁶	Stephenson ⁴⁸		Burnham ⁴³		Howarth ¹⁷		Best ⁴⁹		EPA
Methane, kgCO₂e/GJ(LHV)	Conv	Shale	Conv	Shale	Shale	Conv	Shale	Conv	Shale	Conv	Shale	Conv	Shale	All
Well pad construction	0.1		[0.2 0.1]					[1.6 1.0]		[1.5]		0.16	0.16	
Well drilling	0.2					0.3	0.3					0.23	0.2	
Hydraulic fracturing water	0.3						0.3						0.26	
Chemicals for hydraulic fracturing	0.1												0.07	
Well completion	1.0		1.3		4.7	0.4	1.6		0.8		8.6	0.18	1.2	
Fugitive well emissions	3.4	3.4	1.8	1.8	2.1	0.9	0.9	3.6	3.6	5.0	5.0	2.70	2.70	
Workovers			4.6		4.7				1.5				1.20	
Liquids unloading	2.5		6.6					5.9		0.6		3.80		
Production emissions	5.9	5.1	8.6	7.8	11.5	1.6	3.1	11.1	6.9	5.6	15.1	7.1	5.8	6.8
Processing emissions	1.5	1.5	1.2	1.2	0.6	0.5	0.5	0.8	0.8	0.4	0.4	1.8	1.8	0.9
Transmission emissions	1.9	1.9	2.3	2.3	1.8	1.7	1.7	0.9	0.9	6.8	6.8	1.9	1.9	2.4
Total upstream methane emissions	9.3	8.5	12.1	11.3	13.9	3.8	5.3	12.8	8.6	12.8	22.3	10.8	9.5	10.0
Carbon dioxide, kgCO₂/GJ(LHV)														
Flaring	0.4	0.4	[1.8 2.0]			[2.8 2.8]		0.4	0.4	[4.1 4.1]		0.6	0.6	
Lease/plant energy	3.7	3.7						4.3	4.1			3.2	3.2	
Vented at processing plant	1.0	1.0	0.2	0.2				0.8	0.8			1.2	1.2	
Transmission compressor fuel	0.4	0.4	0.4	0.4		0.2	0.2	0.3	0.3	0.6	0.6	0.4	0.4	
Total upstream CO₂ emissions	5.5	5.5	2.4	2.6		3.0	3.0	5.8	5.6	4.7	4.7	5.4	5.4	4.6
TOTAL UPSTREAM, kgCO₂e/GJ(LHV)	14.8	14.0	14.5	13.9	13.9	6.8	8.3	18.6	14.2	17.5	27.0	16.2	14.9	14.6

* Methane leakage has been converted to kgCO₂e using a GWP of 25. Numbers in all but the EPA column are taken from Table SI-5 in the supplemental information for the paper by Weber and Clavin.⁴⁹ Numbers in the EPA column are my estimates based on the 2012 inventory (Table 4, but adjusted to GWP of 25) and total 2010 U.S. natural gas end-use consumption for energy.⁵⁴ CO₂ emissions in the EPA column include estimates from the EPA 2012 inventory²³ plus emissions from complete combustion of lease and plant fuel in 2010 that I have estimated based on EIA data.⁵⁵

3.1 Leakage During Gas Production, Processing, and Transmission

A careful analysis by Weber and Clavin⁴⁹ encapsulates well the diversity of estimates of upstream emissions that have been published relating to the gas production, processing, and transmission stages. They analyzed in detail the assumptions made in six different studies and took care to normalize estimates from each study to eliminate differences arising from inconsistent assumptions between studies, such as different values for methane GWP, methane fraction in natural gas, and other variables. Weber and Clavin excluded distribution emissions estimates from their comparisons.

Table 6 shows their normalized estimates in units of grams of CO₂-equivalent per megajoule of lower heating value (MJ_{LHV}) natural gas energy,ⁱ assuming a methane GWP of 25. “Best” refers to what Weber and Clavin consider their best estimate based on their analysis, including a Monte Carlo uncertainty analysis, of all of

the studies. For comparison, I have added estimates of emissions based on the EPA 2012 inventory (year 2010 values, adjusted for a methane GWP of 25).

Figure 19, taken from Weber and Clavin, graphs numbers from Table 6, and shows estimated uncertainty ranges.^j For shale gas five of the seven estimates are similar (13.9 to 14.9 gCO₂e/MJ_{LHV}), with estimates based on Howarth¹⁷ and Stephenson⁴⁸ being markedly higher and lower, respectively. Uncertainty ranges in most cases overlap each other. For conventional gas, the estimates based on Burnham and Stephenson represent the highest and lowest estimates, with the others falling in the range 14.5 to 17.5 gCO₂e/MJ_{LHV}.

As seen from Table 6, the largest upstream CO₂ emissions are due to combustion of natural gas used for energy in processing and transmission stages (lease and plant fuel plus transmission compressor fuel). The numbers in Table 6 suggest that the global warming impact of upstream CO₂ emissions accounts for about one third of the combined impact of CO₂ plus methane,

Estimates of Upstream Emissions in the Natural Gas System Vary Widely

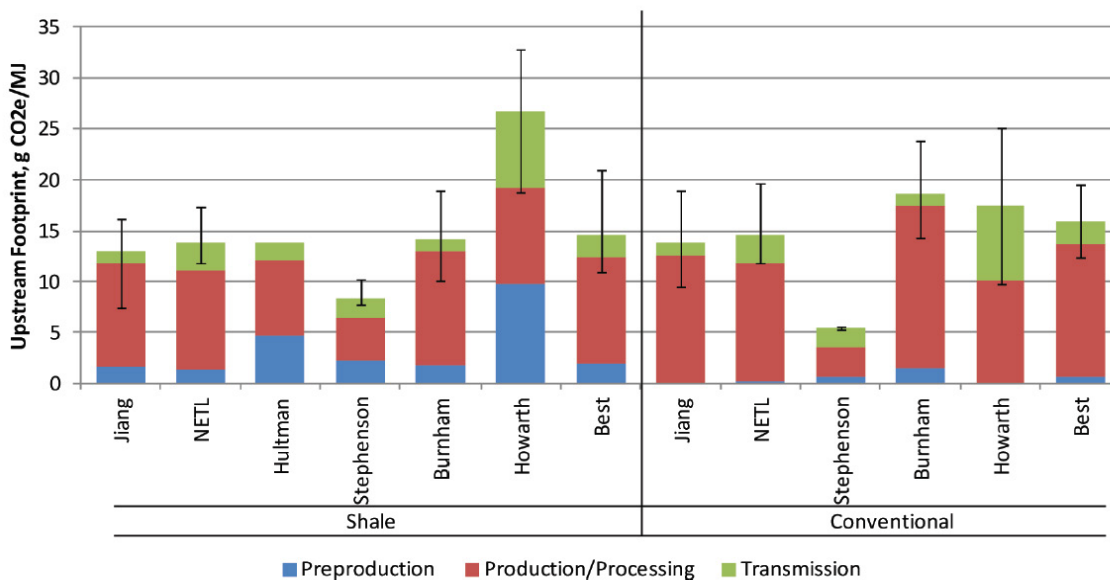

Figure 19. A diversity of estimates exist in the literature for GHG emissions associated with natural gas production, processing, and delivery. This graph, from Weber and Clavin⁴⁹ (and consistent with numbers in Table 6, but using different sub-groupings) shows upstream emissions in units of grams of CO₂e/MJ_{LHV} of natural gas, excluding emissions associated with natural gas distribution. Ranges of uncertainty are also indicated. “Best” refers to Weber and Clavin’s own estimates.

ⁱ The energy content of a fuel can be expressed on the basis of its lower heating value (LHV) or its higher heating value (HHV). The difference between the LHV and HHV of a fuel depends on the amount of hydrogen it contains. The heating value of a fuel is determined by burning it completely under standardized conditions and measuring the amount of heat released. Complete combustion means that all carbon in the fuel is converted to CO₂ and all hydrogen is converted to water vapor (H₂O). The heat released as a result of these oxidation processes represents the LHV of the fuel. If the water vapor in the combustion products is condensed, additional heat is released and the sum of this and the LHV represents the HHV of the fuel. For fuels with low hydrogen content, like coal, relatively little water vapor forms during combustion, so the difference between LHV and HHV is not especially large. The high hydrogen content of methane, CH₄, means the difference between LHV and HHV is more significant. Delivered natural gas, which is mostly methane, has an HHV that is about 11 percent higher than its LHV.

^j Category groupings in Figure 19 are different from those in Table 6, but overall totals are the same.

a not insignificant fraction. However, this is based on assuming a methane GWP of 25 (100-year time frame). Were a higher GWP value (shorter time frame) to be considered, methane would have a higher impact, and the impact of CO₂ would be correspondingly reduced.^k

Leaving aside the upstream CO₂ emissions for the moment, it is possible to remove the complication introduced by the choice of GWP value by expressing the methane emissions in physical terms as a percent of total methane extracted from the ground. This total methane leakage during production, processing, and transmission, as estimated in the various studies, ranges from an average of under 1 percent to 2.6 percent for conventional gas and from 1 percent to 4.5 percent for shale gas (Table 7). The EPA 2012 inventory estimate corresponds to a leakage of 2 percent (which increases to 2.2 percent if leakage from the distribution system is included). The methane leak rates corresponding to the lower and upper ends of the uncertainty ranges for the “Best” case in Figure 19 are 0.9 percent to 3.4 percent for conventional gas and 0.7 percent to 3.8 percent for shale gas. The uncertainty range for shale gas in the highest emissions case (Howarth) corresponds to leakage of 3.3 percent to 7.0 percent^l (not shown in Table 7). Notably, the lower bound of this range is nearly as high as the upper end of the uncertainty ranges for any of the other shale gas results shown in Figure 19. (Howarth’s range for conventional gas is 1.6 percent to 3.8 percent.)

Some perspective on the estimates in Table 7 is provided by O’Sullivan and Paltsev,⁵⁰ who estimate leakage during completion (including hydraulic fracturing) of shale gas wells in the same shale basins (Barnett and Haynesville) as considered by Howarth.^m O’Sullivan and Paltsev drew on gas production data for 1785 shale gas wells that were completed in 2010 in the Barnett formation and 509 in the Haynesville formation. They estimated well completion emissions by assuming that for each well the “flowback” of hydraulic fracturing fluid (see Section 2.1) occurs over a 9 day period and that the amount of gas brought to the surface with the fluid during this period rises linearly from zero at start to a maximum at the end of the period equal to the peak gas production rate reported for the well. They further assume that current field practice for gas handling is represented by an assumption that, on average, 70 percent of the flowback gas is captured for sale, 15 percent is flared at the wellhead (converted to CO₂), and 15 percent is vented without flaring. They acknowledge the uncertainties in this latter assumption, stating that “significant opaqueness surrounds real world gas handling practices in the field, and what proportion of gas produced during well completions is subject to which handling techniques.” Their estimate of average per-well emissions in the Barnett formation is 7 times less than the estimate of Howarth *et al.*,¹⁷ who assume that all flowback gas is vented. For the Haynesville formation, the difference between the estimates in the two studies is a factor of 30.

Table 7. Upstream methane leakage (excluding leakage in distribution systems) as a percentage of methane production for the studies shown in Table 6 and Figure 19.*

	Jiang		NETL		Hultman	Stephenson		Burnham		Howarth		Best		EPA
	Conv	Shale	Conv	Shale	Shale	Conv	Shale	Conv	Shale	Conv	Shale	Conv	Shale	All
	Methane leakage (percentage of methane production)													
Production	1.2	1.0	1.7	1.5	2.2	0.3	0.6	2.2	1.3	1.1	3.0	1.4	1.1	1.37
Processing	0.3	0.3	0.2	0.2	0.1	0.1	0.1	0.2	0.2	0.1	0.1	0.4	0.4	0.19
Transmission	0.4	0.4	0.4	0.4	0.3	0.3	0.3	0.2	0.2	1.4	1.4	0.4	0.4	0.48
TOTAL	1.9	1.7	2.4	2.2	2.7	0.7	1.0	2.5	1.7	2.6	4.5	2.1	1.9	2.02

* Based on Table 6 and (for all but the EPA numbers) energy contents of produced gas per kg of contained methane reported by Weber and Clavin:⁴⁹ Jiang (50 MJ_{LHV}/kgCH₄), NETL (48.8), Hultman (48.2), Stephenson (47.3), Burnham (48.6), Howarth (50.0), and Best (48.8). The EPA estimate assumes a gas energy content of 51.5 MJ_{LHV}/kgCH₄ for consistency with EPA numbers in Table 6.

^k For example, with GWP = 72 (20-year time frame), CO₂ emissions would be less than 15 percent of total CO₂-equivalent emissions in most cases.

^l The paper by Howarth, *et al.*¹⁷ gives total estimated system leakage fractions (including leakage in distribution), of 3.6 percent to 7.9 percent. I have estimated the range for distribution leakage, based on discussion in that paper, to be 0.35 percent to 0.9 percent and removed this from the original Howarth *et al.* estimates to provide a consistent figure for comparison with the others’ results.

^m O’Sullivan and Paltsev also made estimates for wells in the Fayetteville, Marcellus, and Woodford formations.

Table 8. Comparison of estimates for methane leakage during completion of shale gas wells in two different formations.

	O'Sullivan ⁵⁰ kgCH ₄ per well completion	Howarth ¹⁷ (as quoted by O'Sullivan ⁵⁰) kgCH ₄ per well completion
Barnett formation	35.1	252
Haynesville formation	151.3	4638

O'Sullivan and Paltsev report an estimate of total methane emissions from all U.S. shale well completions in 2010 of 216,000 metric tons of methane. EPA's estimate for 2010 using its 2012 inventory methodology was close to this value (181,000 tons), but using the methodology reported in its 2013 inventory, the emissions are more than triple this value (795,000 tons). (See Table 4.) Thus, there continues to be significant uncertainty about what average well completion emissions are.

Uncertainties may be reduced in the future when a new EPA rule takes effect starting in 2015. The rule requires all new hydraulically fractured shale gas wells to use commercially-established "green completion" technologies to capture, rather than vent or flare, methane. The EPA estimates that 95 percent or more of the methane that might otherwise be vented or flared during well completion will be captured for sale. Wyoming and Colorado already require green completions on all shale wells.

The new EPA rule is significant because there is general agreement that methane leakage in the gas production phase is among the most significant leakages in the entire natural gas system, a conclusion supported by some recent measurements of the concentrations of methane in the air above gas wells,^{56,57,58} including a reported leakage rate of 9 percent from oil and gas production and processing operations in the Uinta Basin of Utah,⁵⁹ and 17 percent of production in the Los Angeles Basin.⁶⁰ Such estimates, based on "top-down" measurements, involve large uncertainties, but draw attention to the need for more and better measurements that can help reduce the uncertainty of estimated leakage from natural gas production. Some such measurements are underway.⁶¹

Well completion emissions are only one of several important leakage components in gas production. In Weber and Clavin's review, they identified six assumptions that contribute most significantly to variations in overall estimates from one study to another: *i*) the number of workovers per shale-gas well, *ii*) the well completion and workover emissions factor, *iii*) the liquids unloading emissions factor (for conventional gas wells), *iv*) the rate of fugitive emissions at the wellhead, *v*) the fugitive emissions during gas processing, *vi*) and the EUR.

The last of these requires some explanation. Emissions that occur only once over the lifetime of a well (e.g., well completion emissions) or only a limited number of times (e.g, liquids unloading) are converted into an estimate of emissions per unit of gas produced by dividing the estimated emission by the total gas production from the well over its full lifetime – the well's estimated ultimate recovery (EUR). Because the shale gas industry is still young, there is a limited production history with wells on which to base EUR estimates. O'Sullivan and Paltsev⁵⁰ have noted that there is "appreciable uncertainty regarding the level of ultimate recovery that can be expected from shale wells." The challenge of determining what EUR to use to accurately represent leakage per unit of gas production is compounded by the large and inherent variability in EUR across different wells. Mean EUR values estimated by the U.S. Geological Survey⁶² for wells in different shale formations (based on decline-curve analysis using a limited amount of monthly production data), vary by a factor of 60 from largest to smallest. Within a given formation, the maximum estimated EUR can be up to 1,000 times larger than the estimated minimum EUR. In Weber and Clavin's "Best" estimate in Figure 19, the uncertainty range in emissions results in part

from assumed average EUR values from a low of 0.5 to a high of 5.3 billion cubic feet per well. (The authors state that an EUR of 2 bcf is the “most likely” value.) This order-of-magnitude range in EUR highlights the (significant) uncertainty introduced in using EUR to estimate leakage fractions.

3.2 Leakage from Gas Distribution Systems

Studies reviewed in the previous section were concerned primarily with gas leakage in connection with power generation. Leakage from gas distribution systems was excluded in those studies because most gas-fired power plants receive gas directly from the gas transmission system. But gas used in residential and commercial buildings and smaller industrial facilities – about half of all gas used – passes through the distribution system before reaching a user. The EPA 2012 inventory estimates that leaks in the distribution system account for 13 percent of all upstream methane leakage (Table 4), or less than 0.3 percent of methane produced. But the sheer size and diversity of the gas distribution infrastructure – over a million miles of varying-vintage distribution mains, more than 60 million service pipelines connecting the mains to users, the large number of metering and pressure-regulating stations found at the interface of transmission and distribution systems and elsewhere – and the limited number of leakage measurements that have been made suggest that there could be large uncertainties in the EPA estimate.

One study⁶³ in Sao Paulo, Brazil, which measured leakage from cast-iron distribution mains, highlights the uncertainties. In the 1950s, cast-iron was the standard material used for distribution mains in the U.S. Sao Paulo has a cast-iron distribution network comparable to or younger than the U.S. cast-iron network. Much of the cast iron in the U.S. has been replaced with less-leaky steel or plastic in recent decades, but there are still an estimated 35,000 miles of cast-iron pipe still in everyday use in the U.S. When cast-iron pipes leak it is typically at the joints where 12-foot long pipe sections

are fitted together in “bell and spigot” arrangements. The jute fiber that was routinely used as the sealant dries out over time, leading to leakage. There are about 15 million such joints in the U.S. distribution system today. Comgas, the natural gas utility in Sao Paulo, measured leak rates in over 900 pipe sections in their network. Based on these measurements, they conservatively estimated an average annual leak rate of 803,548 scf per mile of pipe, more than triple the emission factor used in the 2012 EPA inventory (Table 5).⁶⁴ In some 15 percent of the Comgas measurements, emissions were two million scf per mile or higher.

New “top-down” measurement approaches are being pursued to try to improve estimates of leakage from the distribution system. These involve measuring methane concentrations in the air above a defined region and analyzing these in conjunction with wind patterns and other variables to try to estimate what leakage originated from the natural gas system. Recent measurements have identified elevated methane concentrations above urban streets in Boston,⁶⁴ San Francisco,⁶⁵ and Los Angeles.⁶⁶ Work is ongoing in acquiring more measurements to help estimate associated leak rates.^{61,65}

4. Natural Gas vs. Coal in Electricity Generation

The growing use of natural gas for power generation in place of coal makes it particularly important to understand methane leakage and its global warming implications. This issue has been discussed by others^{17,33,43,46,47,49} with varying conclusions due in large part to different methane leakage rate assumptions (as discussed in Section 3.1). In the absence of greater certainty about actual methane leakage rates, it is especially informative to understand the prospective global warming impact of different overall leakage rates when natural gas electricity displaces coal electricity.

Figure 20 shows total lifecycle greenhouse gas emissions associated with natural gas (independent of end use) per unit of energy for different assumed total system leakage rates. The red portion of each bar

⁶¹ Comgas subsequently implemented an effort to place plastic inserts in their cast-iron distribution mains to reduce leakage. The extent to which such leak mitigation measures have been applied in the U.S. is difficult to determine. Some U.S. gas utilities utilize pipe-crawling CISBOTs (cast-iron joint sealing robot) that add sealant to jute-packed joints by self-navigating through distribution mains, thereby reducing the need for more costly excavation to repair or replace pipes.^{65,63}

Even Small Methane Leaks Can Have a Large Global Warming Impact in the Short Term

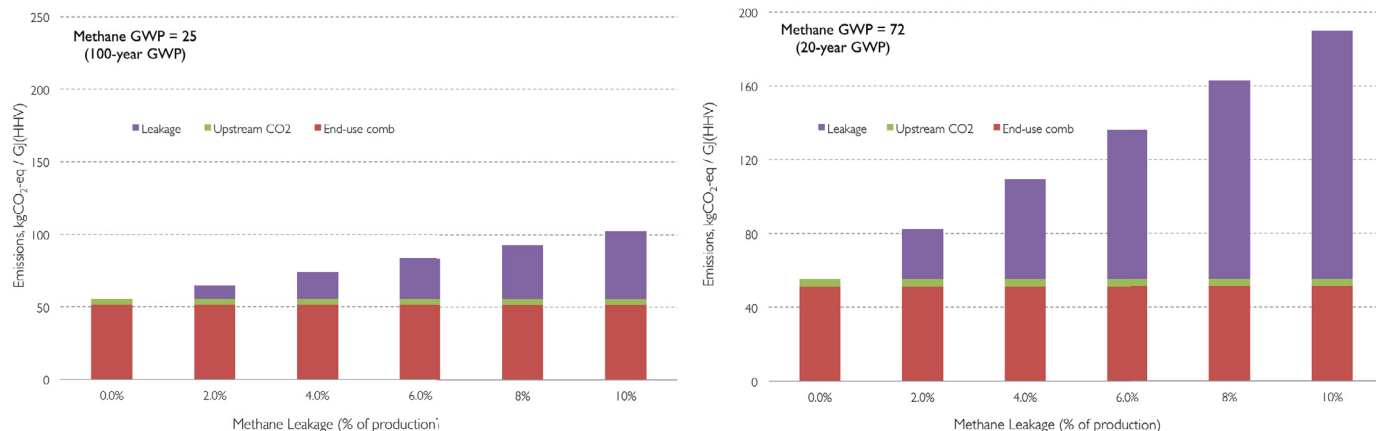

Figure 20. Estimates of greenhouse gas emissions from natural gas production, processing, delivery, and end-use for different assumed rates of upstream methane leakage.

represents end-use combustion emissions.^o Purple is the contribution from methane leakage corresponding to leakage fractions on the x-axis.^p Green represents the comparatively small direct “upstream” CO₂ emissions. (The latter result from combustion of natural gas used as fuel at gas processing plants and in the gas transmission system and from CO₂ that originated underground and was removed from the natural gas during gas processing.^q)

The left and right graphs include the same physical emissions, but represent these using 100-year and 20-year GWPs for methane, respectively. When there is leakage the choice of time horizon affects the global warming impact estimate tremendously, since the GWP for a 20-year time horizon is nearly triple the GWP for a 100 year horizon (Table 3).

As a point of reference, the EPA’s 2012 inventory estimate of GHG emissions from the natural gas system is approximated by the 2 percent leakage case in the left panel (100-yr GWP). Also, as a reminder, other leakage estimates discussed in Section 3.1 ranged from 1 percent to 7 percent (excluding any gas distribution leakage).

With 2 percent leakage and a 100-yr GWP (left-panel), emissions of CO₂ from end-use combustion dominate total emissions. Methane leakage contributes only about 15 percent to the total global warming impact. Only if methane leakage is at the high end in this graph (10 percent leakage) does the global warming impact of leakage approach the level of combustion emissions. When a 20-year GWP is considered instead (right panel), leakage of only 4 percent is sufficient to cause a global warming impact equal to that from gas combustion alone. With 10 percent leakage, the impact of methane leakage is triple the impact from combustion alone.

Going a step further, we can calculate emissions per kilowatt-hour of electricity from natural gas and compare this with those for coal electricity. As noted earlier, natural gas contains much less carbon per unit of energy than coal and can be converted more efficiently into electricity. Power plant efficiencies for both coal and gas are well known. A representative efficiency for a modern natural gas combined cycle power plant is 50 percent (higher heating value basis).⁶⁷ Representative efficiencies for plants using pulverized bituminous coal are 31 percent for a “sub-critical” plant⁶⁸ and 36

^o Assuming complete combustion of natural gas containing 14 kg of carbon per GJ_{HHV}. This corresponds to an assumed natural gas composition by volume of 97.01 percent methane, 1.76 percent ethane, 0.47 percent nitrogen, 0.38 percent CO₂, 0.26 percent propane, and 0.11 percent n-butane and an elemental composition by weight of 74.0 percent C, 24.4 percent H, 0.8 percent N, and 0.7 percent O. The average molecular weight is 16.57 g/mol, and the LHV and HHV are 47.76 MJ/kg and 52.97 MJ/kg, respectively.

^p The methane leakage (in kgCO₂-e/GJ_{HHV}) as a function of the percentage of production leaked is calculated, using the natural gas characteristics in footnote o, as follows: $\frac{\text{kgCO}_2\text{-e}}{\text{GJ}_{\text{HHV}}} = \text{GWP} * \frac{\% \text{ leaked}}{100} * 14 \frac{\text{kgC}}{\text{GJ}_{\text{HHV}}} * \frac{16\text{gCH}_4}{\text{molC}} * \frac{1 \text{molC}}{12\text{gC}}$

^q Upstream CO₂ emissions include those reported by the EPA for the natural gas system²³ plus emissions from combustion of “lease and plant fuel” (which EPA excludes from its inventory for the natural gas system to avoid double counting). Lease and plant fuel emissions are estimated by assuming complete combustion of lease and plant fuel energy used in 2010 as reported by the Energy Information Administration.⁵⁴

With Methane Leakage Natural Gas Power Generation Can Have a Similar or Higher Global Warming Impact as Coal Power Generation

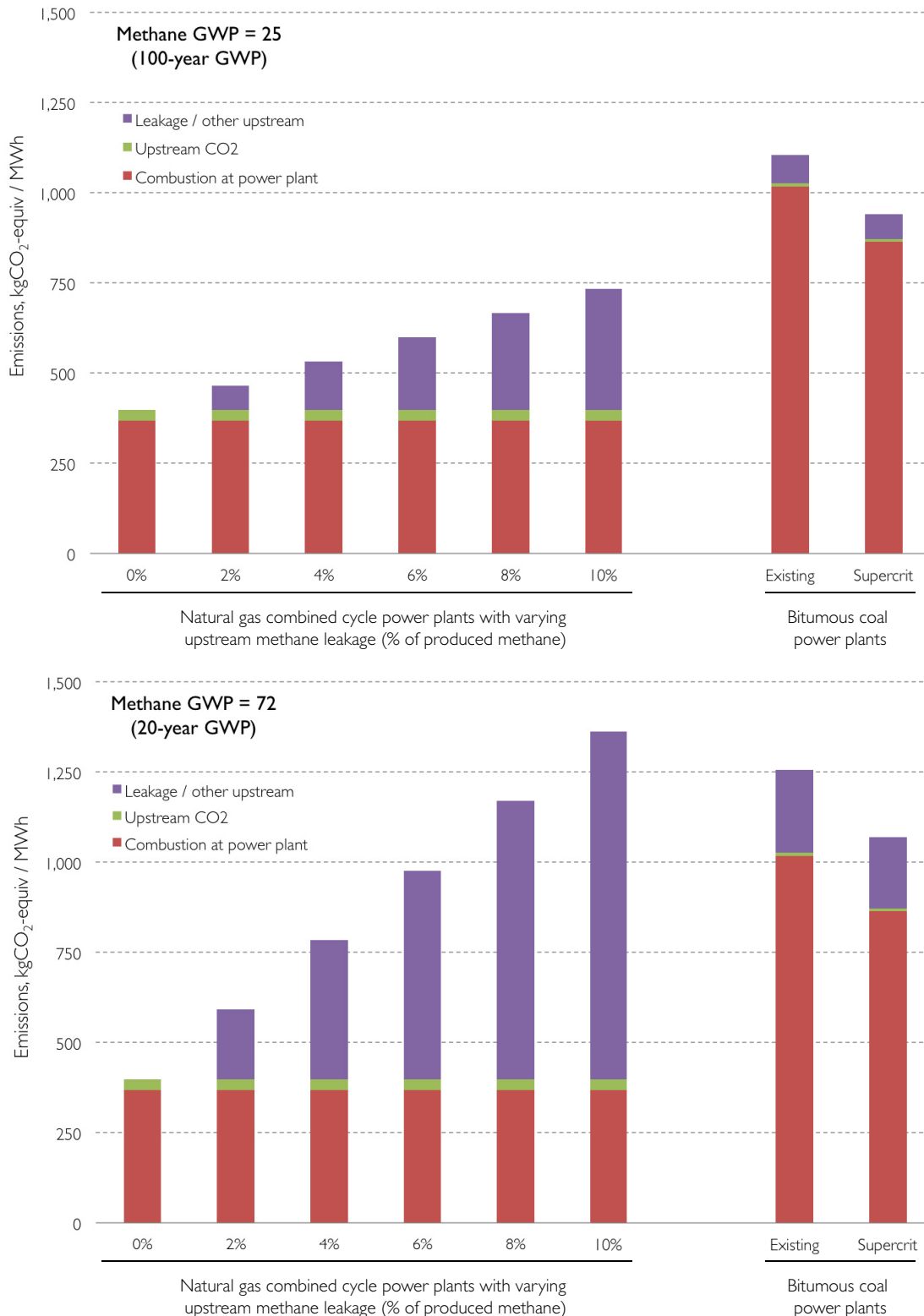

Figure 21. Estimates of greenhouse gas emissions from electricity production from natural gas for different assumed rates of upstream methane leakage and from bituminous coal for typical existing coal plants and for a more efficient variant.^f

^f Based on emissions shown in Figure 20 and power plant fuel consumption of 7172 GJ_{H+V}/kWh a natural gas combined cycle (corresponding to 50.2 percent efficiency),⁶⁷ 11736 GJ_{H+V}/kWh (30.7 percent efficiency) for an existing subcritical coal-fired power plant⁶⁷ and 10019 GJ_{H+V}/kWh for a supercritical coal plant (35.9 percent efficiency).⁶⁸ Upstream CO₂ emissions for the subcritical and supercritical coal plants are 8.34 kg/MWh and 7.48 kg/MWh, respectively, and upstream methane emissions are 3.20 kgCH₄/MWh and 2.76 kgCH₄/MWh, respectively.^{68,69}

percent for a “super-critical” plant.⁶⁹ (Most existing coal power plants use sub-critical steam pressures. Newer plants use super-critical pressures.)

With these efficiencies, Figure 21 shows our estimates of GHG emissions per kWh of electricity generated from natural gas (with different methane leakage rates) and from bituminous coal, assuming methane GWP time horizons of 100 years (top panel) and 20 years (bottom panel). These calculations include estimates of the “upstream” emissions associated with coal electricity, including estimated methane emissions that accompany mining of bituminous coal.^{68,69}

With the 100-yr time horizon (top panel), the GHG emissions for a kWh of electricity from a natural gas plant are half the emissions from a kWh from an existing coal plant if methane leakage is under about 5 percent. Even with leakage as high as 10 percent, the natural gas kWh still has a lower global warming impact than the coal kWh – about one-third less.

In contrast, when the 20-yr time horizon is considered (bottom panel), leakage must be limited to

about 2 percent for the natural gas kWh to have half the global warming impact of an existing coal plant’s kWh. If leakage is about 8 percent, the natural gas kWh is no better for the climate than the kWh from an existing coal plant.

The comparisons in Figure 21 do not address the question of what is the “correct” GWP value to use in comparing the global warming impact of electricity from gas and coal. Alvarez *et al.*¹⁸ have proposed a method for assessing the climate impact of a switch from one technology to another (such as coal to gas electricity generation) that involves more than one type of greenhouse gas emission, for example methane and CO₂. They define a technology warming potential (TWP) that represents the ratio of the time-dependent global warming potential of technology “A” divided by the time-dependent global warming potential of technology “B” that it replaces. By explicitly including the different atmospheric lifetimes of methane and CO₂, this method yields a ratio, for any time horizon of interest, that represents the relative global warming potential of switching from technology

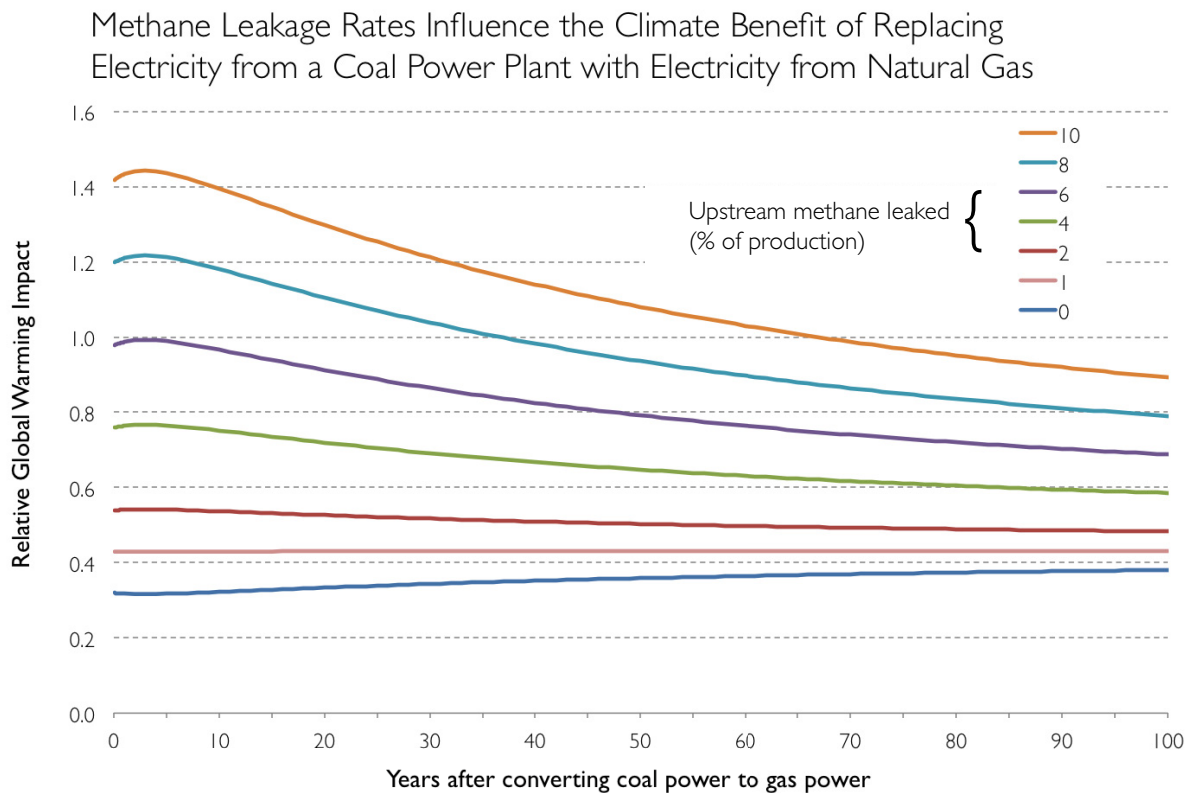

Figure 22. Global warming impact of shifting electricity generation from a coal power plant to a natural gas power plant in year zero and continuing that generation from gas each year thereafter, assuming different methane leakage rates in the natural gas system. Natural gas is friendlier for the climate for values less than 1.0.⁵

⁵ Assumed heat rates for electricity generation are 7172 kJ_{HHV}/kWh (6798 BTU/kWh) for NGCC and 10550 kJ_{HHV}/kWh (10000 BTU/kWh) for existing coal plants. Upstream emissions for coal are as described for subcritical coal in footnote r.

“A” to technology “B”. The ratio varies with the time horizon due to the different atmospheric lifetimes of methane and CO₂. A ratio less than one at a particular point in time after a switch is made from “A” to “B” means that technology “A” has a lower global warming potential than technology “B” over that time frame.

Combining the TWP methodology of Alvarez *et al.* with our leakage assumptions, Figure 22 shows the global warming impact of replacing the electricity from a coal-fired power plant with natural gas electricity and then maintaining that natural gas generation for every subsequent year thereafter. Results are shown for different assumed total methane leakage rates expressed as a fraction of gas produced. For a time-frame of interest (x-axis), if the corresponding value on the y-axis is less than one, then the switch from coal to gas produces some level of climate benefit relative to maintaining electricity generation using coal. For example, if the y-axis value is 0.5 at some point in time, NGCC electricity has half as much global warming potential as coal over that time period.

Many authors have suggested that switching from coal to gas electricity halves the global warming impact of electricity generation. Figure 22 indicates that this is true if methane leakage is about 1.5 percent of production. If leakage were as high as 6 percent, the switch to gas would still be better for the climate than coal over any time period considered, although barely so in the earlier years after the switch. If leakage were 8 percent, switching from coal to gas would require 37 years before any climate benefit is achieved. With 10 percent leakage it takes 67 years. At these higher leak rates, a 50 percent climate benefit would not be realized for well over a century.

Figure 22 represents the impact of shifting one power plant worth of electricity generation from coal to gas. An important follow-on question is what would be the global warming impact of shifting over time the whole fleet of coal power plants to gas. To provide some context in answering the question, it is helpful to know that the average rate at which coal electricity

generation decreased over the decade from 2002 to 2012 in the U.S. was 2.4 percent per year. The annual percentage rate of reduction has been rising in recent years (Table 9). The decreased generation from coal has been predominantly replaced by increased generation from natural gas. (The combined electricity generation from gas plus coal grew an average of less than half of one percent per year during the past decade, Table 9.)

We extend the method presented by Alvarez *et al.* to analyze shifting of the whole coal fleet to gas over time. We assume an average annual percentage reduction in electricity generated from coal and a corresponding increase in electricity generated from gas,[†] with total electricity production from coal plus gas remaining the same each year.[‡] If we assume a methane leakage rate of 2 percent of production, then Figure 23 shows the prospective global warming impact of switching from coal to natural gas electricity at different annual rates (compared to not replacing any coal electricity). With a 10 percent per year switching rate, it would take 29 years to replace 95 percent of coal generation. For the other cases, 95 percent coal replacement would be reached in 39 years (7.5 percent per year), 59 years (5 percent per year), 118 years (2.5 percent per year), or more than 200 years (1 percent per year).

As full replacement of coal is approached, the impact on global warming reaches a limiting value. Over a long enough time horizon, all of the cases will approach the same relative impact level of around 0.5 (for an assumed 2 percent leakage) but, importantly, this impact level is reached more slowly when coal replacement occurs more slowly. The slower the approach to the 0.5 level, the more rapid the rate of warming. Considering an often-used target year of 2050, 37 years from today, we see that the higher replacement rates (5, 7.5, and 10 percent per year) each achieves 40 percent or more reduction in global warming potential – approaching the maximum level reachable in the longer term. At the 2.5 percent per year replacement rate (roughly the average actual rate over the past decade), only a 29 percent reduction in warming potential is achieved by 2050.

[†] For a constant annual percentage conversion of coal electricity to gas electricity, the fraction of original coal electricity converted to gas each year is $[r * (1 - r)^{(t-1)}]$ where r is the annual percentage reduction in coal electricity and t is the number of years from the start of the conversion process. (Conversion begins in year $t = 1$.)

[‡] The Technology Warming Potential (TWP) defined by Alvarez *et al.*¹⁸ (Equation 2 in their paper; with $L/L_{ref} = 1$) is used here to calculate the reduction in Global Warming Potential from substituting a unit amount of coal-generated electricity with gas-generated electricity in a given year and continuing to produce that unit amount of electricity from gas in subsequent years. (Figure 22 shows the result of this calculation.) When the amount of electricity made from natural gas is not constant every year but increases year to year (as coal electricity generation decreases year to year) the climate impact of each new annual increment of gas electricity is assessed using the TWP. Then, the climate impact of the electricity generated from coal and gas in total in any year is the sum of climate impacts caused that year by each new increment of gas-generated electricity added from the start of the counting period up to that year plus the impact of the reduced amount of coal-generated electricity being produced in that year. Mathematically, the climate impact in total from the start of a shift from coal to gas over some number of years, N , is calculated as: $\int_{t=1}^N [r(1-r)^{(t-1)} * TWP(N+1-t)] dt + \{1 - \int_{t=1}^N [r(1-r)^{(t-1)}] dt\}$ where r is the annual percentage reduction in coal electricity and $TWP(N+1-t)$ is given by Equation 2 in Alvarez *et al.*

Table 9. U.S. coal and natural gas electricity generation 2002-2012 (left)⁶ and annual percentage reduction in coal electricity generation when averaged over different time periods (right).

Electricity Generated (1000 MWh per year)				Average Annual Reduction in Coal Electricity	
	Coal	Natural Gas	Coal + Gas	Time Period	
2002	1,933,130	691,006	2,624,136	2002 - 2012	2.4 percent
2003	1,973,737	649,908	2,623,645	2003 - 2012	2.9 percent
2004	1,978,301	710,100	2,688,401	2004 - 2012	3.3 percent
2005	2,012,873	760,960	2,773,833	2005 - 2012	4.0 percent
2006	1,990,511	816,441	2,806,952	2006 - 2012	4.4 percent
2007	2,016,456	896,590	2,913,046	2007 - 2012	5.5 percent
2008	1,985,801	882,981	2,868,782	2008 - 2012	6.5 percent
2009	1,755,904	920,979	2,676,883	2009 - 2012	4.8 percent
2010	1,847,290	987,697	2,834,987	2010 - 2012	9.4 percent
2011	1,733,430	1,013,689	2,747,119	2011 -2012	12.5 percent
2012	1,517,203	1,230,708	2,747,911	-	-

At 2 Percent Methane Leakage Rate, Replacing Coal Plants with Natural Gas Plants can Achieve Significant Climate Benefits this Century

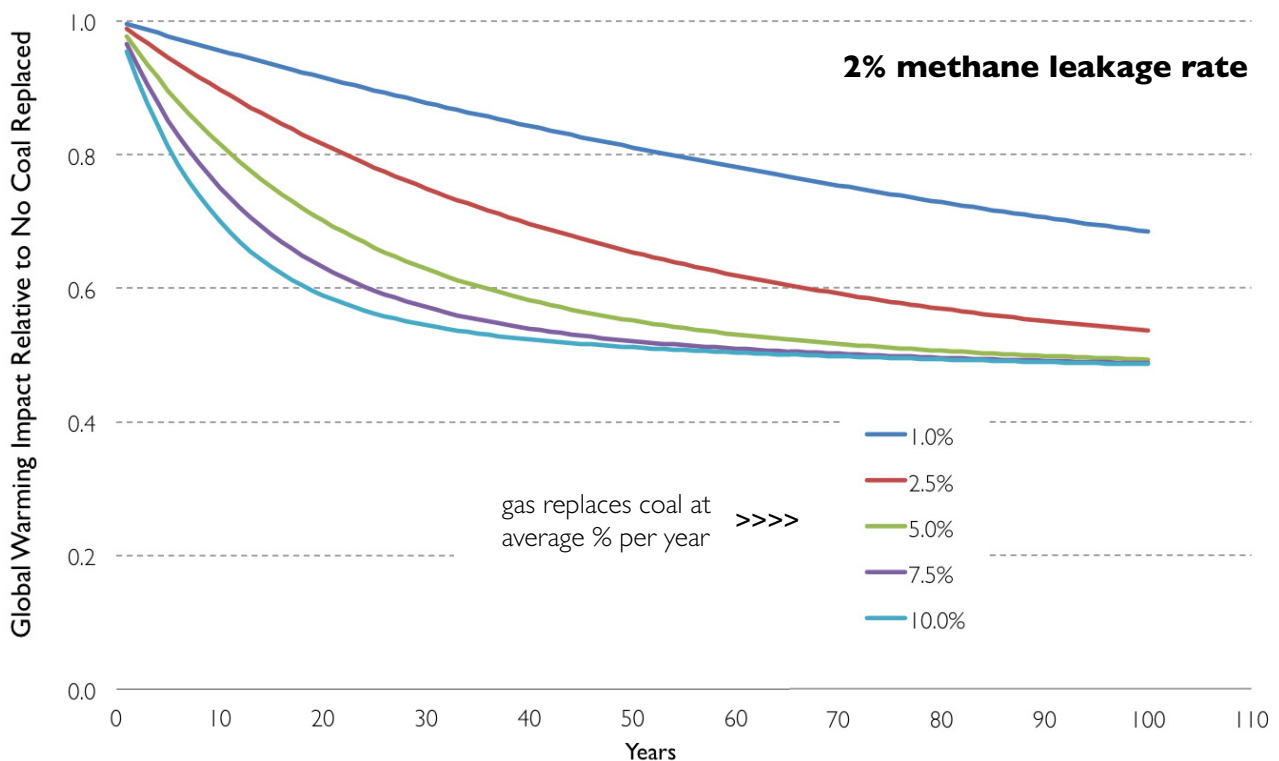

Figure 23. Relative global warming impact of natural gas combined cycle power replacing existing coal-fired power generation at different annual rates. In all cases the assumed methane leakage is 2 percent of production.

At 5 Percent Methane Leakage Rate, Replacing Coal Plants With Natural Gas Plants Offers Only Modest Benefits Before 2050

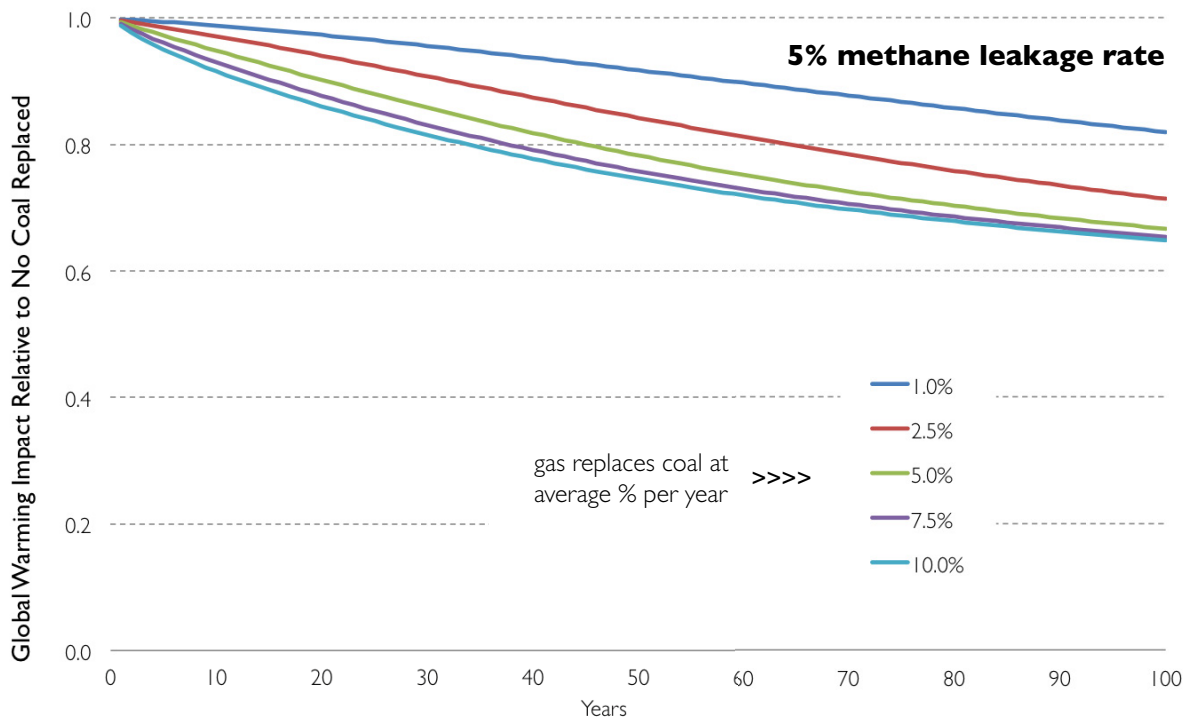

Figure 24. Relative global warming impact of natural gas combined cycle power replacing existing coal-fired power generation at different annual rates. In all cases the assumed methane leakage is 5 percent of production.

At 8 Percent Methane Leakage Rate, Replacing Coal Plants with Natural Gas is Worse For the Climate for at Least 45 Years

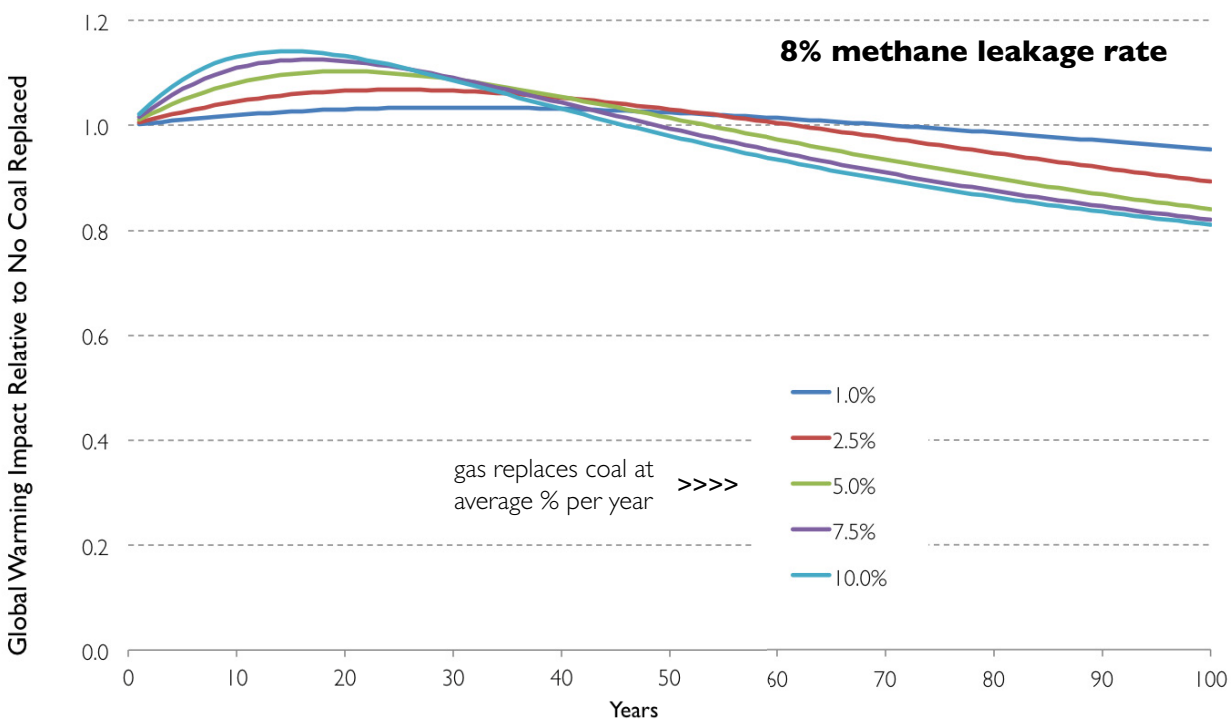

Figure 25. Relative global warming impact of natural gas combined cycle power replacing existing coal-fired power generation at different annual rates. In all cases the assumed methane leakage is 8 percent of production.

The same analysis can be carried out for a different assumed methane leakage rate. Figure 24 shows results for 5 percent leakage. Because of the higher methane leakage, the impact of switching from coal to gas is not as substantial as with lower leakage. In fact, by 2050, even the highest coal replacement rate of 10 percent/year achieves only about a 20 percent reduction in warming potential. The 2.5 percent replacement rate achieves only a 12 percent reduction compared with no coal-to-gas conversion.

As expected based on Figure 22, if leakage exceeds 6 percent, there would initially be negative impacts of switching from coal to gas nationally. With 8 percent

leakage, a global warming benefit of switching from coal to gas is reached only after 45 years or more (Figure 25).

Finally, the different coal-to-gas substitution rates in Figure 23 and Figure 24 would have different gas supply requirements. If we consider 2013 as year 1 in these graphs, then the amount of additional gas supplies required in the U.S. to sustain the different rates of coal-to-gas substitution are as shown in Figure 26. Shown for comparison are the Energy Information Administration (EIA) projections of new gas supplies (for all end-uses of gas). New gas supplies could be higher than EIA projects, but the higher coal substitution rates (5 to 10

New Natural Gas Supply Needed to Replace Coal Plants with Natural Gas Plants at Different Annual Rates

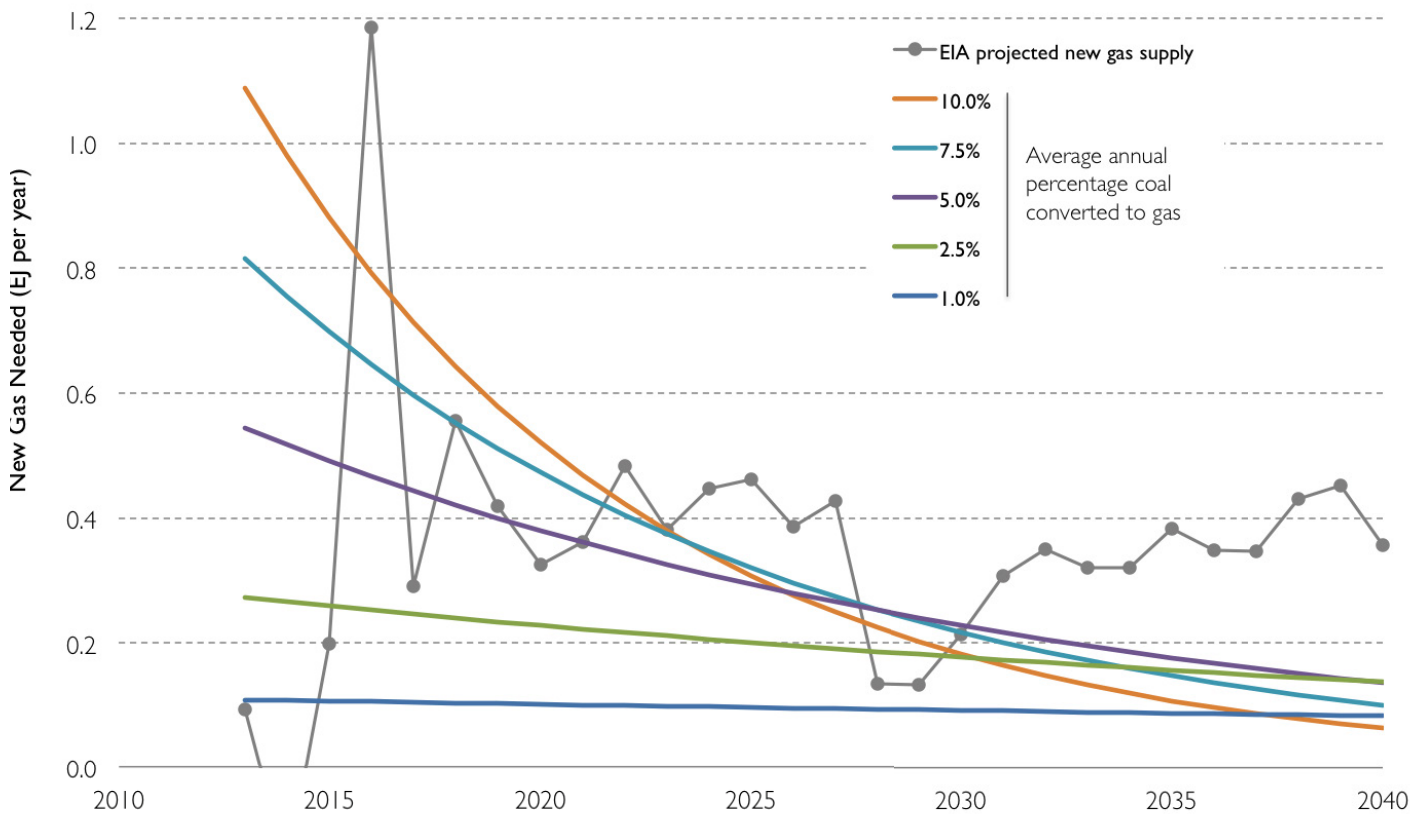

Figure 26. Additional gas required each year (compared to preceding year) under different scenarios. The solid lines represent the new gas required for electricity generation to replace coal-fired generation in the U.S. at the annual percentage rates indicated. (Coal-fired generation in 2012 was 1517 TWh. Gas generation that replaces coal is assumed to require 7,172 kJ of gas per kWh generated, corresponding to a heat rate of 6,798 BTU/kWh.) The black line is the new gas supply (for all gas uses) projected by the Energy Information Administration in its 2013 Annual Energy Outlook (Early Release) Reference Scenario⁷ (There are approximately 1.1 EJ per trillion cubic feet (TCF) of gas.)

percent/year) would be difficult to achieve in the early years with the gas supply levels currently projected by the EIA, considering demands for gas from users other than electric power plants are also projected by EIA to grow during the projection period. In this context, the 2.5 percent per year rate may be an achievable average coal-to-gas shifting rate over the next several decades. In that case, the achievable reduction in global warming impact from substituting gas for coal out to 2050 would be 12 percent to 29 percent, considering methane leakage of 2 percent to 5 percent (Figure 23 and Figure 24). To achieve better than this would require other lower-carbon options, such as reduced electricity consumption and/or increased electricity supply from nuclear, wind, solar, or fossil fuel systems with CO₂ capture and storage to provide some of the substitution in lieu of gas over this time frame.

This analysis considered no change in leakage rate or in the efficiencies of power generation over time. The benefit of a switch from coal to gas would obviously increase if leakage were reduced and/or natural gas power generating efficiency increased over time.

References

- (1) Rogner, H. (Convening Lead Author), *et al.* (2012), “Energy Resources and Potentials,” chapter 7 in *The Global Energy Assessment*, Johansson, *et al.* (eds.), Cambridge University Press.
- (2) BP (2012). Statistical Review of World Energy, <http://www.bp.com/sectionbodycopy.do?categoryId=7500&contentId=7068481>
- (3) U.S. Energy Information Administration (2012). *Annual Energy Review*, U.S. Dept. of Energy, September, <http://www.eia.gov/totalenergy/data/annual/index.cfm#consumption>
- (4) Ground Water Protection Council and ALL Consulting (2009). *Modern Shale Gas Technology Development in the United States: A Primer*, National Energy Technology Laboratory, April.
- (5) U.S. Energy Information Administration, U.S. Natural Gas Development Wells Drilled (count), U.S. Department of Energy, 2012, http://tonto.eia.gov/dnav/ng/hist/e_ertwg_xwcd_nus_cm.htm
- (6) U.S. Energy Information Administration, Electric Power Monthly, U.S. Department of Energy, February 2013, <http://www.eia.gov/electricity/monthly/pdf/epm.pdf>
- (7) Energy Information Administration (2012). *Annual Energy Outlook 2013, Early Release*, U.S. Dept. of Energy, December, <http://www.eia.gov/forecasts/aeo/er/index.cfm>
- (8) Harrison, M.R., Shires, T.M., Wessels, J.K., and Cowgill, R.M. (1997). “Methane Emissions from the Natural Gas Industry,” Project Summary, EPA/600/SR-96/080, EPA, June.
- (9) U.S. Energy Information Administration, http://www.eia.gov/pub/oil_gas/natural_gas/feature_articles/2010/ngpps2009/.
- (10) U.S. Energy Information Administration, http://www.eia.gov/pub/oil_gas/natural_gas/analysis_publications/ngpipeline/ngpipelines_map.html.
- (11) U.S. Energy Information Administration, http://www.eia.gov/cfapps/ngqs/images/storage_2010.png.
- (12) U.S. Energy Information Administration, <http://www.eia.gov/analysis/studies/usshalegas/images/shalemap-lg.png>
- (13) U.S. Geological Survey (August 2012). http://certmapper.cr.usgs.gov/data/noga00/natl/tabular/2012/Summary_12_Cont_Gas.pdf
- (14) U.S. Energy Information Administration (2013). *Natural Gas Annual*, <http://www.eia.gov/naturalgas/annual/>.
- (15) Forster, P., V. Ramaswamy, P. Artaxo, T. Berntsen, R. Betts, D.W. Fahey, J. Haywood, J. Lean, D.C. Lowe, G. Myhre, J. Nganga, R. Prinn, G. Raga, M. Schulz and R. Van Dorland (2007). “Changes in Atmospheric Constituents and in Radiative Forcing”. In: *Climate Change 2007: The Physical Science Basis. Contribution of Working Group I to the Fourth Assessment Report of the Intergovernmental Panel on Climate Change* [Solomon, S., D. Qin, M. Manning, Z. Chen, M. Marquis, K.B. Averyt, M. Tignor and H.L. Miller (eds.)]. Cambridge University Press, Cambridge, United Kingdom and New York, NY, USA.
- (16) Shindell, D.T., G. Faluvegi, D.M. Koch, G.A. Schmidt, N. Unger, and S.E. Bauer (2009). “Improved Attribution of Climate Forcing to Emissions,” *Science*, 326(30 Oct): 716-718.
- (17) Howarth, R.W., R. Santoro, and A. Ingraffea (2011). “Methane and the greenhouse-gas footprint of natural gas from shale formations: a letter,” *Climatic Change*, 106:679–690.

- (18) Alvarez, R.A., S.W. Pacala, J.J. Winebrake, W.L. Chameides, and S.P. Hamburg (2012). “Greater focus needed on methane leakage from natural gas infrastructure,” *PNAS*, 109(17): 6435-6440. See also the online supporting information accompanying the article.
- (19) <http://www.epa.gov/climatechange/ghgemissions/usinventoryreport.html>
- (20) EPA (2013). Inventory of U.S. Greenhouse Gas Emissions and Sinks: 1990-2011, Environmental Protection Agency, Washington, DC, April 12. <http://www.epa.gov/climatechange/Downloads/ghgemissions/US-GHG-Inventory-2013-Main-Text.pdf>
- (21) EPA (2012). *Inventory of U.S. Greenhouse Gas Emissions and Sinks: 1990-2010*, 430-R-12-001, Environmental Protection Agency, Washington, DC, April.
- (22) Taken from presentations by EPA staff at the “Stakeholder Workshop on Natural Gas in the Inventory of U.S. Greenhouse Gas Emissions and Sinks,” September 13, 2012. <http://www.epa.gov/climatechange/ghgemissions/Sept2012stakeholderworkshop.html>
- (23) EPA (2012). “Methodology for Estimating CH₄ and CO₂ Emissions from Natural Gas Systems,” Section 3.4 of Annex 3 of the Inventory of U.S. Greenhouse Gas Emissions and Sinks: 1990-2010, 430-R-12-001, Environmental Protection Agency, Washington, DC, April. <http://www.epa.gov/climatechange/ghgemissions/Sept2012stakeholderworkshop.html>
- (24) Innovative Environmental Solutions (2009). “Field Measurement Program to Improve Uncertainties for Key Greenhouse Gas Emission Factors for Distribution Sources,” Project No. 20497, Gas Technology Institute, Des Plaines, IL, Nov. 2009.
- (25) EPA/GRI (1996). *Methane Emissions from the Natural Gas Industry*. Harrison, M., T. Shires, J. Wessels, and R. Cowgill (eds.), 15 volumes, Radian International LLC for National Risk Management Research Laboratory, Air Pollution Prevention and Control Division, Research Triangle Park, NC. EPA-600/R-96-080a. Available at EPA website: <http://www.epa.gov/gasstar/tools/related.html>.
- (26) EPA, Gas Star Program: <http://www.epa.gov/gasstar/>.
- (27) Numbers are from tables in Annex 3 of the EPA GHG Emissions Inventories published in 2009, 2010, 2011, 2012, and the 2013 inventory.
- (28) Waltzer, S. (2012). “Liquids Unloading,” presentation at the ‘Stakeholder Workshop on Natural Gas in the Inventory of U.S. Greenhouse Gas Emissions and Sinks,’ U.S. Environmental Protection Agency, 13 Sept, Wash. D.C.
- (29) U.S. Energy Information Administration, http://www.eia.gov/dnav/ng/ng_sum_lsum_dcu_nus_a.htm.
- (30) http://www.eia.gov/pub/oil_gas/natural_gas/analysis_publications/ngpipeline/compressorMap.html
- (31) U.S. Energy Information Administration (2008). “Distribution of Natural Gas: The Final Step in the Transmission Process,” June. <http://www.eia.gov/FTP/ROOT/features/ldc2008.pdf>
- (32) Pipeline and Hazardous Materials Safety Association, U.S. Department of Transportation. <http://www.phmsa.dot.gov/>
- (33) Skone, T.J., J. Littlefield, and J. Marriot, “Life Cycle Greenhouse Gas Inventory of Natural Gas Extraction, Delivery and Electricity Production,” DOE/NETL-2011/1522, National Energy Technology Laboratory, October.
- (34) Broderick, J., Anderson, K., Wood, R., Gilbert, P., Sharmina, M., Footitt, A., Glynn, S., and Nicholls, F. (2011). “Shale gas: an updated assessment of environmental and climate change impacts,” The Tyndall Centre, University of Manchester, UK, November.

- (35) Clark, C., A. Burnham, C. Harto, and R. Horner (2012). “Hydraulic Fracturing and Shale Gas Production: Technology, Impacts, and Policy,” Argonne National Laboratory, September 10.
- (36) Forster, D. and J. Perks (2012). “Climate impact of potential shale gas production in the EU,” Report to the European Commission DG CLIMA, July 30.
- (37) Howarth, R., D. Shindell, R. Santoro, A. Ingraffea, N. Phillips, and A. Townsend-Small (2012), “Methane Emissions from Natural Gas Systems,” Background paper prepared for the National Climate Assessment, Reference number 2011-0003, February.
- (38) Ritter, K. (API), A. Emmert, M. Lev-On, and T. Shires (2012), “Understanding Greenhouse Gas Emissions from Unconventional Natural Gas Production,” 20th International Emissions Inventory Conference, August, Tampa, FL.
- (39) Santoro, R.L., R.H. Howarth, and A.R. Ingraffea (2011). “Indirect Emissions of Carbon Dioxide from Marcellus Shale Gas Development,” A Technical Report from the Agriculture, Energy, & Environment Program at Cornell University, June.
- (40) Hughes, J.D. (2011). “Lifecycle Greenhouse Gas Emissions from Shale Gas Compared to Coal: An Analysis of Two Conflicting Studies,” Post-Carbon Institute, July.
- (41) Fulton, M., Mellquist, N., Kitasei, S., and Bluestein, J. (2011). “Comparing Life-Cycle Greenhouse Gas Emissions from Natural Gas and Coal,” Deutsche Bank Group Climate Change Advisors, August 25.
- (42) Lechtenböhmer, S., Altmann, M., Capito, S., Matra, Z., Weindorf, W., and Zittel, W. (2011). “Impacts of Shale Gas and Shale Oil Extraction on the Environment and on Human Health,” IP/A/ENVI/ST/2011-07, prepared for the European Parliament’s Committee on Environment, Public Health and Food Safety, June.
- (43) Burnham, A., J. Han, C.E. Clark, M. Wang, J.B. Dunn, and I. Palou-Rivera (2012). “Life-Cycle Greenhouse Gas Emissions of Shale Gas, Natural Gas, Coal, and Petroleum,” *Environmental Science and Technology*, 46, 619–627.
- (44) Cathles III, L.M., L. Brown, and M. Taam, and A. Hunter (2012). “A commentary on ‘The greenhouse-gas footprint of natural gas in shale formations’ by R.W. Howarth, R. Santoro, and Anthony Ingraffea,” *Climatic Change*, 113:525–535.
- (45) Howarth, R.W., R. Santoro, and A. Ingraffea (2012). “Venting and leaking of methane from shale gas development: response to Cathles et al.,” *Climatic Change*, 113:537-549.
- (46) Hultman, N., D. Rebois, M. Scholten, and C. Ramig (2011). “The greenhouse impact of unconventional gas for electricity generation,” *Environmental Research Letters*, Vol. 6.
- (47) Jiang, M., W.M. Griffin, C. Hendrickson, P. Jaramillo, J. Van Briesen, and A. Venkatesh (2011). “Life cycle greenhouse gas emissions of Marcellus shale gas,” *Environmental Research Letters*, Vol. 6.
- (48) Stephenson, T., J.E. Valle, and X. Riera-Palou (2011), “Modeling the Relative GHG Emissions of Conventional and Shale Gas Production,” *Environmental Science and Technology*, 45: 10757–10764.
- (49) Weber, C.L. and C. Clavin (2012). “Life Cycle Carbon Footprint of Shale Gas: Review of Evidence and Implications,” *Environmental Science and Technology*, 46: 5688-5695.
- (50) O’Sullivan, F. and Paltsev, S. (2012). “Shale gas production: potential versus actual greenhouse gas emissions,” *Environmental Research Letters*, Vol. 7.

- (51) Laurenzi, I.J. and Jersey, G.R. (2013). "Life Cycle Greenhouse Gas Emissions and Freshwater Consumption of Marcellus Shale Gas," *Environmental Science and Technology*, published online, 2 April.
- (52) EPA, (2010). Greenhouse Gas Emissions Reporting from the Petroleum and Natural Gas Industry: Background Technical Support Document, Environmental Protection Agency, Washington, DC.
- (53) API (2009). Compendium of Greenhouse Gas Emissions Methodologies for the Oil and Natural Gas Industry, American Petroleum Institute, Washington, DC.
- (54) U.S. Energy Information Administration, http://www.eia.gov/dnav/ng/ng_cons_sum_dcu_nus_a.htm.
- (55) U.S. Energy Information Administration, http://www.eia.gov/dnav/ng/ng_cons_sum_dcu_nus_a.htm.
- (56) Caulton, D., Shepson, P., Cambaliza, M., Sparks, J., Santoro, R., Sweeney, C., Davis, K., Lauvaus, T., Howarth, R., Stirm, B., Sarmiento, D. and Belmecheri, S. (2012). "Quantifying Methane Emissions from Shale Gas Wells in Pennsylvania," A21J-03, Annual Meeting of the American Geophysical Union, San Francisco, December.
- (57) Karion, A., Sweeney, C., Petron, G., Frost, G., Trainer, M., Brewer, A., Hardesty, R., Conley, S., Wolter, S., Newberger, T., Kofler, J., and Tans, P. (2012). "Estimate of methane emissions from oil and gas operations in the Uintah Basin using airborne measurements and Lidar wind data," A21J-01, Annual Meeting of the American Geophysical Union, San Francisco, December.
- (58) Petron, G., et al. (2012). "Hydrocarbon emissions characterization in the Colorado Front Range: A pilot study," *Journal of Geophysical Research*, 117(D04304).
- (59) Tollefson, J. (2013). "Methane leaks erode green credentials of natural gas," *Nature* 493(7430), January 2.
- (60) Peischl, J., Ryerson, T.B., Brioude, J., Aikin, K.C., Andrews, A.E., Atlas, E., Blake, D., Daube, B.C., de Gouw, J.A., Dlugokencky, E., Frost, G.J., Gentner, D.R., Gilman, J.B., Goldstein, A.H., Harley, R.A., Holloway, J.S., Kofler, J., Kuster, W.C., Lang, P.M., Novelli, P.C., Santoni, G.W., Trainer, M., Wofsy, S.C., and Parrish, D.D. (2013). "Quantifying sources of methane using light alkanes in the Los Angeles basin, California," *Journal of Geophysical Research: Atmospheres*, DOI: 10.1002/jgrd.50413 (accepted online) 17 April.
- (61) Hamburg, S., "Measuring fugitive methane emissions from fracking," Ecowatch, January 4, 2013. <http://ecowatch.org/2013/fugitive-methane-emissions-fracking/>
- (62) Oil and Gas Assessment Team (2012). "Variability of Distributions of Well-Scale Estimated Ultimate Recovery for Continuous (Unconventional) Oil and Gas Resources in the United States," Open-File Report 2012-1118, U.S. Geological Survey, Washington, DC.
- (63) Bylin, C., L. Cassab, A. Cazarini, D. Ori, D. Robinson, and D. Sechler (2009). "New Measurement Data has Implications for Quantifying Natural Gas Losses from Cast Iron Distribution Mains," *Pipeline and Gas Journal*, 236(9): Sept.
- (64) Phillips, N.G., R. Ackley, E.R. Crosson, A. Down, L.R. Hutyrá, M. Brondfield, J.D. Karr, K. Zhao, and R.B. Jackson (2013). "Mapping urban pipeline leaks: Methane leaks across Boston," *Environmental Pollution*, 173: 1-4.
- (65) McKenna, P. (2011). "Methane leaks foil clean gas future," *New Scientist*, 9 July.
- (66) Wennberg, P.O., Mui, W., Wunch, D., Kort, E.A., Blake, D.R., Atlas, E.L., Santoni, G.W., Wofsy, S.C., Diskin, G.S., Jeong, S., and Fisher, M.L. (2012). "On the Sources of Methane to the Los Angeles Atmosphere," *Environmental Science and Technology*, 46: 9282-9289.

- (67) National Energy Technology Laboratory (2010). Cost and Performance Baseline for Fossil Energy Plants Volume 1: Bituminous Coal and Natural Gas to Electricity, (Revision 2), DOE/NETL-2010/1397, NETL, November.
- (68) Skone, T. and James, R. (2010). Life Cycle Analysis: Existing Pulverized Coal (EXPC) Power Plant, DOE/NETL-403-110809, National Energy Technology Laboratory, September 30.
- (69) Skone, T. and James, R. (2010). Life Cycle Analysis: Supercritical Pulverized Coal (SCPC) Power Plant, DOE/NETL-403-110609, National Energy Technology Laboratory, September 30.

This page intentionally blank



Princeton

One Palmer Square, Suite 330
Princeton, NJ 08542
Phone: +1 609 924-3800

Call Toll Free

+1 877 4-CLI-SCI (877 425-4724)

www.climatecentral.org